

SAILPLANE FLIGHT MANUAL

Model: LAK-19

Serial Number: _____

Registration: _____

Date of Issue: _____

Pages identified by "Appr." are approved by the European Aviation Safety Agency

Original date of approval: 16 October 2006
EASA TCDS No. A.012

This Manual should always be kept on board of the sailplane

This sailplane is to be operated in compliance with the information and limitations contained herein.

0.1 RECORD OF REVISIONS

Any revision of the present manual, except actual weighing data, must be recorded in the following table and in the case of approved sections endorsed by the responsible airworthiness authority.

The new or amended text in the revised page will be indicated by a black vertical line in the left hand margin, and the revision number and date will be shown on the bottom left hand of the page.

Rev. No.	Affected Section	Affected Pages	Date of Issue	Approval	Date of approval	Date of Insertion	Signature
5	All sections	All pages	2003 06 02				
6	1	1.3	2004 09 24				
		1.5	2004 09 24				
	2	2.5	2004 09 24				
		2.6	2004 09 24				
		2.7	2004 09 24				
		2.8	2004 09 24				
	4	4.3	2004 09 24				
		4.4	2004 09 24				
		4.5	2004 09 24				
		4.6	2004 09 24				
	5	5.4	2004 09 24				
	6	6.3	2004 09 24				
		6.5	2004 09 24				
		6.6	2004 09 24				
		6.7	2004 09 24				
		6.8	2004 09 24				
		6.10	2004 09 24				
		6.11	2004 09 24				
		6.12	2004 09 24				
		6.13	2004 09 24				
		6.14	2004 09 24				
		6.15	2004 09 24				
		6.16	2004 09 24				
		6.17	2004 09 24				
		6.18	2004 09 24				
		6.19	2004 09 24				
Rev. No 6	Author	Date:2004 09 24			Page		
	K.Juoëas				0.1		

Rev. No.	Affected Section	Affected Pages	Date of Issue	Approval	Date of approval	Date of Insertion	Signature
7	7	7.3	2007 07 09				
Rev. No 7	Author		Date:2007 07 09			Page	
	K.Juoëas					0.2	

0.2 LIST OF EFFECTIVE PAGES

Section	Page	Date of Issue	Section	Page	Date of Issue
0	0.1	2004 09 24	5	5.1	2003 06 02
	0.2	2007 07 09		Appr.5.2	2003 06 02
	0.3	2007 07 09		Appr.5.3	2003 06 02
	0.4	2003 06 02		Appr.5.4	2004 09 24
1	1.1	2003 06 02	6	6.1	2003 06 02
	1.2	2003 06 02		6.2	2003 06 02
	1.3	2004 09 24		6.3	2004 09 24
	1.4	2003 06 02		6.4	2003 06 02
	1.5	2004 09 24		6.5	2004 09 24
	1.6	2003 06 02		6.6	2004 09 24
2	2.1	2003 06 02	7	6.7	2004 09 24
	Appr.2.2	2003 06 02		6.8	2004 09 24
	Appr.2.3	2003 06 02		6.9	2003 06 02
	Appr.2.4	2003 06 02		6.10	2004 09 24
	Appr.2.5	2004 09 24		6.11	2004 09 24
	Appr.2.6	2004 09 24		6.12	2004 09 24
	Appr.2.7	2004 09 24		6.13	2004 09 24
	Appr.2.8	2004 09 24		6.14	2004 09 24
3	3.1	2003 06 02	7	6.15	2004 09 24
	Appr.3.2	2003 06 02		6.16	2004 09 24
	Appr.3.3	2003 06 02		6.17	2004 09 24
	Appr.3.4	2003 06 02		6.18	2004 09 24
	Appr.3.5	2003 06 02		6.19	2004 09 24
4	4.1	2003 06 02	8	7.1	2003 06 02
	Appr.4.2	2003 06 02		7.2	2003 06 02
	Appr.4.3	2004 09 24		7.3	2007 07 09
	Appr.4.4	2004 09 24		7.4	2003 06 02
	Appr.4.5	2004 09 24		7.5	2003 06 02
	Appr.4.6	2004 09 24		7.6	2003 06 02
	Appr.4.7	2003 06 02		7.7	2003 06 02
	Appr.4.8	2003 06 02		8.1	2003 06 02
	Appr.4.9	2003 06 02		8.2	2003 06 02
	Appr.4.10	2003 06 02		8.3	2003 06 02
			8.4	2003 06 02	
			9	9.1	2003 06 02

0.3 TABLE OF CONTENTS

		Section
GENERAL	(a non-approved section)	1
LIMITATIONS	(an approved section)	2
EMERGENCY PROCEDURES	(an approved section)	3
NORMAL PROCEDURES	(an approved section)	4
PERFORMANCE	(a partly approved section)	5
WEIGHT AND BALANCE	(a non-approved section)	6
SAILPLANE AND SYSTEM DESCRIPTION		7
	(a non-approved section)	
SAILPLANE HANDLING, CARE AND MAINTENANCE		8
	(a non-approved section)	
SUPPLEMENTS	(a non-approved section)	9

Section 1

1. General
- 1.1 Introduction
- 1.2 Certification basis
- 1.3 Warnings, cautions and notes
- 1.4 Descriptive data
- 1.5 Three view drawing
- 1.6 Abbreviations

1.1 Introduction

This sailplane flight manual has been prepared to provide pilots and instructors with information for the safe and efficient operation of the LAK-19 sailplane.

This manual includes the material required to be furnished to the pilot by JAR 22. It also contains supplemental data supplied by the sailplane manufacturer.

1.2 Certification basis

This type of sailplane has been approved by the Lithuanian Directorate of Civil Aviation in accordance with: Airworthiness Requirements: JAR 22 Sailplanes and Powered Sailplanes, Change 5, Issued 28 October 1995.

The Type Certificate Number 15 has been issued on 31 May, 2002. Category of Airworthiness: Utility.

1.3 Warnings, cautions and notes

The following definitions apply to warnings, cautions and notes used in the flight manual.

- Warning:** Means that the non-observation of the corresponding procedure leads to an immediate or important degradation of the flight safety.
- Caution:** Means that the non-observation of the corresponding procedure leads to a minor or to a more or less long term degradation of the flight safety.
- Note:** Draws the attention on any special item not directly related to safety by which is important or unusual.

1.4 Descriptive data

The LAK-19 is a new generation of FAI standard class sailplane (wing span 15 and 18m) with the additional wingtips with or without winglets for both 15m and 18m configurations, designed according to JAR-22 category “U” specifications. It is a midwing glider with T-tail, retractable main landing gear and 180 liter water ballast.

The sailplane is made of hybrid composite materials (kevlar, carbon, glass fibre). The wing spar is made of modern carbon rods GRAPHLITE SM315 and has double T section. The airbrakes are situated on upper surfaces only. The wing airfoil is LAP 92-130/15 and it passes into the LAP 92-150/15 in the tip.

The cockpit is of monocoque construction. The manually control seat pan and an adjustable seat back together with optimally arranged control elements offer notable comfort on the long flights. The one piece Plexiglas canopy hinges forward. On the left side there is a sliding window with additional ventilation. The instrument panel folds up together with canopy

The retractable landing gear with shock absorber has 5.00-5 6 ply tire. The main wheel brake is actuated via the airbrake control handle. The rudder pedals are adjustable in flight. All controls, including the water ballast system, hook up semi-automatically. The towing hook is mounted near main landing gear or in front pilot cockpit at the bulkhead. Also both towing hooks can be mounted with one handle operating. Wings incorporate fork-type spar tips, joined with two pins.

The T-tail (fixed stabilizer with elevator) of the LAK-19 provides stable and responsive pitch characteristics. The elevator hooks up automatically during assembly.

The glider is fitted with a fin ballast tank (capacity 8 liter) in order to adjust the optimum C.G. position.

The wing water ballast is filled in and poured out through the holes at the bottom of the wings.

Antenna is mounted in the vertical fin.

Technical data

Wing span, m	15.0	18.0
Fuselage length, m	6.53	6.53
Height, m	1.29	1.29
Max gross weight, kg	480	500
Mean aerodynamic chord, m	0.626	0.598
Wing area, m ²	9.06	9.8
Wing loading, kg/m ²		
minimal	31.5	30.1
maximal	53	51

1.5 Three view drawing

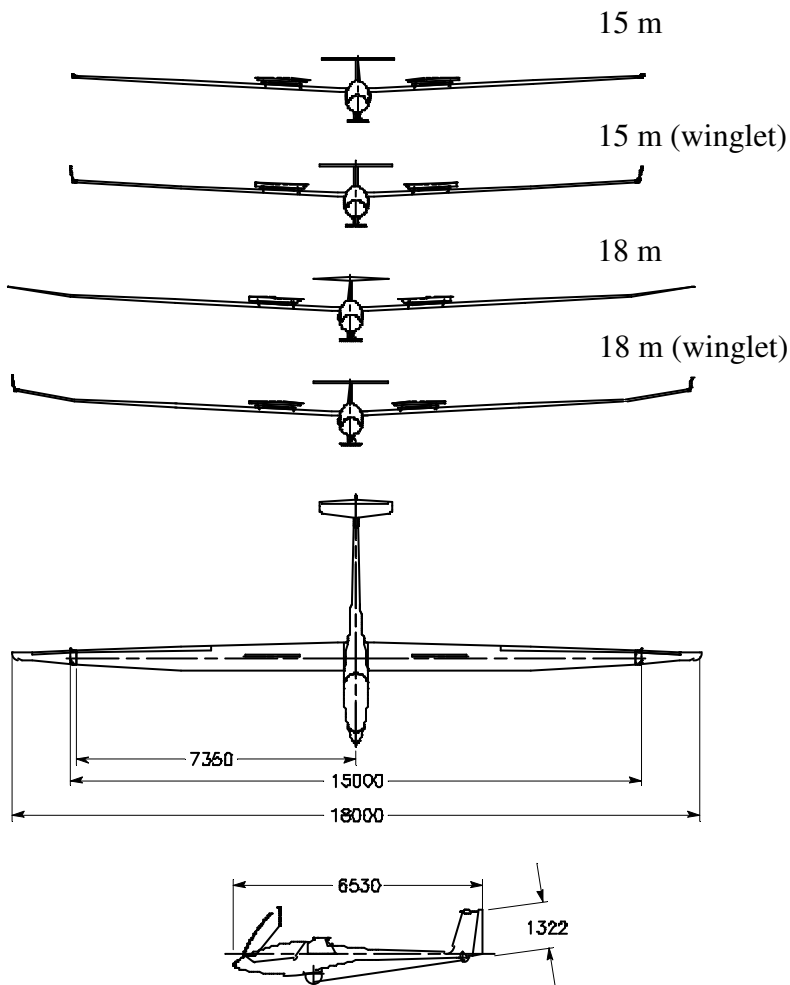

1.6 Abbreviations

CAS	- calibrated airspeed means indicated airspeed of a sailplane, corrected for position (due to position of pressure ports on sailplane) and instrument error. Calibrated airspeed is equal to true airspeed in standard atmosphere at sea level.
C.G.	- centre of gravity.
daN	- decanewton.
h	- hour.
IAS	- indicated airspeed means the speed of a sailplane as shown on its pitot – static airspeed indicator system error.
m	- meter.
kg	- kilogram.
km	- kilometre.
s	- second.

Section 2

- 2. Limitations
 - 2.1 Introduction
 - 2.2 Airspeed
 - 2.3 Airspeed indicator markings
 - 2.4 Weight
 - 2.5 Centre of gravity
 - 2.6 Approved manoeuvres
 - 2.7 Manoeuvring load factors
 - 2.8 Kinds of operation
 - 2.9 Minimum equipment
 - 2.10 Aerotow, winch and auto tow-launching
 - 2.11 Other limitations
 - 2.12 Limitation placards

2.1 Introduction

Section 2 includes operation limitations, instrument markings and placards necessary for safe operation of the LAK-19 sailplane, standard systems and standard equipment. The limitations included in this section have been approved by the Lithuanian Civil Aviation Administration.

2.2 Airspeed

Airspeed limitations and their operational significance are shown below:

	Speed	IAS, km/h		Remarks
		15 m	18 m	
V_{NE}	Never exceed speed	275	275	Do not exceed this speed in any operation and do not use more than 1/3 of control deflection from 0 m to 4000 m
		260	260	up to 5000 m
		245	245	up to 6000 m
		220	220	up to 8000 m
		195	195	up to 10000 m
V_{RA}	Rough air speed	205	205	Do not exceed this speed except in smooth air and then only with caution. Rough air is in lee wave rotor, thunderclouds, etc.

	Speed	IAS, km/h		Remarks
		15 m	18 m	
V _A	Manoeuvring speed	205	205	Do not make full or abrupt control movement above this speed, because under certain conditions the sailplane may be over stressed by full control movement
V _w	Maximum winch and autotow launch speed	140	140	Do not exceed this speed during winch or autotow-launching
V _T	Maximum aero towing speed	160	160	Do not exceed this speed during aero towing
V _{LO}	Maximum landing gear operations speed	205	205	Do not extend or retract the landing gear above this speed

Warning: At higher altitudes the true airspeed is higher than the indicated airspeed, so V_{NE} is reduced with altitude.

2.3 Airspeed indicator markings

Airspeed indicator markings and their colour code significance are shown below:

Marking	IAS value or range	Significance
Green Arc	98-205 km/h	Normal Operating Range: Lower limit is $1.1 V_{S1}$ at maximum weight and most forward C.G. Upper - limit rough air speed.
Yellow Arc	205÷275 km/h	Manoeuvres must be conducted with caution and only in smooth air.
Red Line	275 km/h	Maximum speed for all operations.
Yellow Triangle	95 km/h	Approach speed at maximum weight without water ballast

2.4 Weight

Maximum take-off mass

with water ballast for:	15m	480 kg
	18m	500 kg

Note: When landing on the rough hard surface always dump all water ballast before landing.

Minimum pilot and parachute weight	70 kg
Maximum pilot and parachute weight	110 kg
Maximum mass of all non lifting parts.....	233 kg
Maximum mass in baggage area	7 kg

Caution: Heavy pieces of baggage must be secured to the baggage compartment floor.

2.5 Centre of gravity

Position of C.G. in flight:

- front limit	182 mm aft of root chord leading edge
- rear limit	305 mm aft of root chord leading edge

Warning: The sailplane may be safely operated only when loaded in range defined in section 6 of this manual.

2.6 Approved manoeuvres

This sailplane is certified for normal gliding in the "Utility" category according to JAR-22. Aerobatic manoeuvres are not permitted.

2.7 Manoeuvring load factors

Limit load factors are:

- for $V_A=205$ km/h airspeed +5.3 /-2.65
- for $V_{NE}=275$ km/h airspeed +4.0 /-1.5

2.8 Kinds of operation

Flights must be conducted under Day / VFR conditions.

Where permitted by national regulations, cloud flying may be conducted but only with 15m wings (including 15m winglets) and without water ballast. Consider the different national legal requirements (for e.g. additional equipment) for cloud flying (see also point 2.9). Aerobatic manoeuvres are not permitted.

2.9 Minimum equipment

As minimum equipment only the instruments and equipment specified here and in the equipment list (see Maintenance Manual Section 2) are admissible:

- airspeed indicator, scale 50-300 km/h, with range markings (see Section 2.3).
- altimeter with altitude corrector and fine range pointer.
- four point symmetrical seat harness.
- transceiver.
- power supply (fin battery).
- outside air temperature (OAT) gauge (if water ballast is carried).
- parachute or seatback cushion (about 10 cm thick).
- emergency locator transmitter (ELT)*.

* - if required by National regulations.

For cloud flying the following additional equipment is required:

Variometer

Magnetic Compass compensated in the sailplane.

Turn and Bank indicator, non-icing.

Parachute, automatic or manual opening type.

Non-icing airspeed system.

The minimum equipment must correspond with national regulations.

2.10 Aero tow, winch and auto tow launching

The maximum launch speeds are:

Aerotow.....	160 km/h,
Winch - Launch.....	140 km/h.

For all of the above launching methods a weak link of 650 daN must be used in the launch cable or towrope.

For aerotow, the towrope must be at least 20m long.

Warning: For winch or auto tow launch only C.G. hook can be used.

Warning: Aerotow launches are only allowed at the aerotow hook.

2.11 Other limitations

Crosswinds:

The maximum crosswind component according to the airworthiness requirements for take-off and landing is 4.16 m/s (15 km/h).

Water Ballast

Filling of the wing water ballast tanks must result in a symmetrical loading condition only. After filling, balance the wings by dumping enough water from the heavy wing to achieve lateral balance. Flight with leaking water ballast is not permitted as this may result in asymmetrical loading.

Warning: Maximum take-off weight must not exceeded.

2.12 Limitation placards

The limitation placards are in cockpit.

Joint Stock Company "SPORTINĒ AVIACIJA"					
Model: LAK-19	Date of manufacture:	Serial No. _____			
AIR SPEED DATA AND LOADING PLACARD 15m/18m					
MAXIMUM AIR SPEEDS	km/h				
Never exceed	[V _{NE}]	275			
Rough air	[V _{RA}]	205	Maximum mass		
Manoeuvring	[V _A]	205	including water ballast	480/500	kg
Aerotow	[V _T]	160	Maximum cockpit load	110	kg
Winch-launching	[V _w]	140	Minimum cockpit load	70	kg
Landing gear	[V _{Lo}]	205	Recommended weak link	6500	N
Aerobatic manoeuvres are not permitted					

Maximum Baggage weight 7 kg
(Soft items only)

Baggage Compartment
Placard

The high altitude flights limitation placard is shown in section 4.5.7.

Section 3

- 3 Emergency procedures
- 3.1 Introduction
- 3.2 Canopy jettison
- 3.3 Bailing out
- 3.4 Stall recovery
- 3.5 Spin recovery
- 3.6 Spiral dive recovery
- 3.7 Recovery from unintentional cloud flying
- 3.8 Flight with asymmetric water ballast
- 3.9 Emergency wheel up landing
- 3.10 Ground loop
- 3.11 Ditching landing in water

3.1 Introduction

Section 3 provides a checklist and explanations for coping with emergencies that may occur. Emergency situations can be minimized by proper pre-flight inspections and maintenance.

3.2 Canopy jettison

The following steps accomplish canopy jettison:

1. Pull the red canopy jettison handle aft to the limit of its travel.
2. Release the handle.

The canopy jettison handle is located on the instrument panel and has an icon describing its function. A compression spring in the canopy hinge pushes canopy upward and allows the airflow to lift front of the canopy upward while the rear of the frame pivots about a small lip on the fuselage. This system is designed to lift the canopy up and away from the flying glider to allow the pilot a quick bail out from the cockpit.

If necessary, you have to push the canopy upwards with both hands on the Plexiglas.

Warning: The red handle of the spring-type mechanism on a canopy hinge must be in unlocked (working) position.

3.3 Bailing out

First jettison the canopy then unlock the safety harness and bail out. The low walls of the cockpit allow for a quick push off exit.

It is recommended that bail procedures be practiced on the ground at the beginning of each flying season.

3.4 Stall recovery

Stall recovery is accomplished by easing the stick forward and if necessary picking up a dropping wing with sufficient opposite rudder.

3.5 Spin recovery

Apply full opposite rudder against the direction of rotation and ease the stick forward until the rotation stops. At aft C.G. positions the glider may move temporary in a nose up position making it necessary to apply full stick forward. As rotation stops centralize the controls and carefully pull out of the dive. The ailerons should be kept neutral during spin recovery.

Recovery from unintentional spins should be done immediately.

Caution: Altitude loss due an incipient spin from straight flight with prompt recovery is 30 m, increasing till 60 m from circling flight and 60 m till 110 m with airbrakes extended.. Maximum speed during recovery is 200 km/h.

3.6 Spiral dive recovery

The glider with front C.G. position, when the rudder is undeflected, slowly move nose down and go to the spiral dive.

Apply rudder and aileron in the direction opposite to the spiral dive rotation and carefully pull out of the dive.

3.7 Recovery from unintentional cloud flying

Spins are not to be used to loose altitude. In an emergency pull out the dive brakes fully before exceeding a speed of 205 km/h and fly normally until leaving the cloud. At higher speeds, up to V_{NE} , pull out the dive brakes very carefully and expect high aerodynamic forces and g-loads.

3.8 Flight with asymmetrical water ballast

If you suspect that the water ballast is not dumping symmetrically you should close the dump valves immediately to avoid greater asymmetry. Asymmetry can be verified by the necessary aileron deflection in straight flight at low airspeeds.

When flying with asymmetric water ballast you must increase your airspeed, especially in turns, so that you can avoid stall at all costs. Should the aircraft enter a spin under these conditions, aggressive stick forward spin recovery will be necessary. Fly the landing pattern and touch down with approximately 10 km/h faster than normal and after touch down attempt to control the bank angle to avoid the heavy wing from touching the ground too early.

3.9 Emergency wheel up landing

An emergency wheel up landing is not recommended since the absorption capability of the fuselage is much smaller than that of the landing gear. If the landing gear cannot be extended the landing touchdown should be at slow speed.

3.10 Ground loop

If there is a risk of overshooting the landing area an intentional ground loop may be initiated by forcing a wing tip to the ground and at the same time you should PUSH the stick forward to lighten the load on the tail wheel and apply the opposite rudder.

3.11 Ditching landing on water

Our experience shows that in ditching the cockpit area lightly will be forced downward under water. Therefore, an emergency landing on water is recommended only with the landing gear extended and then only as a last resort.

Section 4

- 4 Normal procedures
- 4.1 Introduction
- 4.2 Rigging and de-rigging
- 4.3 Daily inspections
- 4.4 Pre-flight inspection
- 4.5 Normal procedures and recommended speeds
 - 4.5.1 Aero tow launch
 - 4.5.2 Winch- launch or auto tow
 - 4.5.3 Free flight
 - 4.5.4 Low speed flight and stalling behaviour
 - 4.5.5 Approach and landing
 - 4.5.6 Flight with water ballast
 - 4.5.7 High altitude flights
 - 4.5.8 Flight in rain

4.1 Introduction

This section provides checklists and explanations of procedures for conducting normal operating procedures. Normal procedures associated with optional equipment can be found in Section 9.

4.2 Rigging and de-rigging

The following procedures are recommended for rigging and de-rigging the LAK-19 sailplane:

1. Clean and lubricate all pins, bushings and control connections. Inspect the pins and bushings for burrs and gouges.
2. Support the fuselage and keep it upright, open the canopy and lower the landing gear. Place the control stick in the centre of its travel. Position the dive brake handle near its most forward position. Put the water ballast control in the forward, closed position.
3. Be sure the dive brake system in the wings is not locked. Remove any supports or locks over the ailerons.
4. Insert the left wing spar fork into the fuselage. As the wing root approaches the fuselage look to be sure the automatic hook ups for aileron and dive brake properly engage. Look to see if the water ballast control is engaging correctly. After the wing is pushed into position support the wing tip.

Note: It's not allowed to rig or de-rig wings with 18m wingtips or winglets.

5. Insert the right wing spar into the fuselage. As the wing root approaches the fuselage look to be sure the automatic hook ups for aileron and dive brake properly engage. Look to see if the water ballast control is engaging correctly. Line up the main pin bushings. Insert both spar pins fully. Lock the main wing pin handles.

Warning: - Lock the main wing pin handles with fixing studs.

6. Install winglets or wing tips and lock.

7. **Caution:** Insert battery into vertical tail fin, connect to system and check operation.

Slide the stabilizer onto the drive pins and look to be sure the automatic hook ups for elevator properly engage. Push the stabilizer all the way onto the drive pins. Screw the locking bolt and be sure, that bolt fixed. After removing the assembly tool place a piece of glider tape over the locking bolt.

Warning: Before unscrew the connection bolt unfix the bolt.

8. Apply sealing tape to the wing/fuselage gaps.

9. Perform a positive control check of all controls.

10. If water ballast is necessary, fill each wing tank according to the loading chart (see Section 6) and confirm symmetrical loading by balancing at the wing tip. A light coating of waterproof grease applied to the dump valve seat will help insure the valve is leak free.

Warning: Allow wing tanks to vent while filling. Do not fill with pressure exceeding 1 psi / 0.06 bar as the wing shell could be damaged. Check for proper dump valve operation prior to flight. Do not exceed the maximum gross weights.

11. Install total energy tube and temporary equipment (barographs etc.)
12. Perform Daily Inspection.
13. De-rigging follows the reverse order of rigging. Confirm that water ballast has been dumped before de-rigging.
Also see Maintenance Manual Section 3.
Note: Remove the stabilizer before removing the wings.

4.3 Daily Inspections

Prior daily's flight the glider must receive a daily inspection. As a minimum check the following items. If any problems are found they must be corrected before flying.

1. Check a sailplane fore part of fuselage.
2. Check in a pilot cockpit:
 - the pilot cockpit canopy glass,
 - operation of pilot cockpit canopy lock, canopy jettison system,
 - canopy jettison system in working position,
 - wings connection pins fastening,
 - operation of towing hook,
 - operation of water ballast system,
 - operation of control systems of ailerons, elevator, rudder and airbrakes,
 - operation of control system of pilot cockpit ventilation,
 - operation of a trimmer,
 - operation of flight instruments,
 - radio communication,
 - safety belts.
3. Check main wheel tyre and operation of wheel brake.

4. Check the left wing:
 - upper and lower wing surfaces,
 - leading edge,
 - upper and lower surfaces of ailerons,
 - deflections of ailerons and their clearances,
 - airbrakes for proper function and locking,
 - fixing of ailerons attachment to wing,
 - clearance in respect of the fuselage,
 - winglets or wing tips installed and locked.
5. Check function of control systems (of an aileron, airbrake), their connections to corresponding control systems in the fuselage.
6. Check the fuselage surface.
7. Check a stabilizer, an elevator and a rudder:
 - surfaces,
 - deflections and clearances of controls,
 - fixing of joint of the stabilizer attachment to the fin,
 - clearance of the stabilizer with respect to the fin.
8. Check the right wing (analogically as for the left wing according to i.4).
9. Check fin battery installed.

Also see Maintenance Manual Section 3.

Caution: After a hard landing or if high loads have been experienced a complete inspection according to the Maintenance Manual Section 5.5 must be performed. Contact the manufacture for assistance as required.

4.4 Pre-flight inspection

1. Main spar pins installed and locked.
2. Controls checked for operation and freedom of movement.
3. Lead or water ballast for underweight pilot installed or filled.
4. Fin battery installed.
5. Tail dolly removed.
6. Canopy jettison system in working position.
7. Pilot safety harness connected.
8. Seat back and rudder pedals adjusted.
9. All control knobs within reach.
10. Water ballast checked, dump valve closed and vents open.
11. Airbrakes closed and locked.
12. Trim set to take-off position.
13. Check wheel brake.
14. Altimeter set correctly.
15. Check direction of wind component.
16. Close and lock canopy.

4.5 Normal procedures and recommended speeds

Normal flight operation procedures and the corresponding recommended air speeds are as follows.

4.5.1 Aero tow launch

Trim should be set forward of neutral.

Warning: aerotow launches are only allowed at the aerotow hook.

Warning: when water tanks are partially filled, keep wings horizontal before take off to avoid unequal water distribution.

Weak link in tow cable max 650 daN. Use wheel brake during tightening of tow cable to avoid rolling over tow cable.

Minimum aero tow speed:

without water ballast.....100 km/h.

with water ballast.....120 km/h.

4.5.2 Winch- launch or auto tow

Adjust backrest and rudder pedals properly. Tighten seat belt harness. Trim should be set forward of neutral.

Warning: when water tanks are partially filled, keep wings horizontal before take off to avoid unequal water distribution.

Weak link in tow cable max 650 daN. Use wheel brake during tightening of tow cable to avoid rolling over tow cable. Pronounced forward stick pressure is required during transition arc.

Warning: for winch or auto tow launch only C.G. hook can be used.

Warning: it is prohibited to use aero tow hook for winch launch.

Minimum winch launch / auto tow speed:

without water ballast.....100 km/h.

with water ballast.....120km/h.

4.5.3 Free flight

The circling airspeed, depending on the bank angle and sailplane weight ranges between 95 and 105km/h.

High speed flight up to 275 km/h.

4.5.4 Low speed flight and stalling behaviour

The LAK-19 behaves normally in slow and stalled flight.

With a forward C.G. position it is no stall warning, but the stall characteristics are very gentle and large aileron deflections can be applied without dropping a wing.

At rearward C.G. positions airflow separation over the fuselage results in buffeting and gives warning to an impending stall at the speed 1 ÷ 2 km/h. Full and sudden aileron or rudder deflections will result in a spiral dive, spin entry or slide slip depending on the C.G. position.

Caution: Altitude loss due to an incipient spin from straight flight with prompt recovery is approximately 30 m, increasing till 60 m from circling flight.

4.5.5 Approach and landing

In light winds and without water ballast the approach to landing should be flown at about 90 km/h. Stronger winds require increased airspeeds. The very effective dive brakes make a short landing possible; however, do not approach too slowly with fully extended dive brakes as the aircraft may drop during the flare out. The LAK-19 should touch down on the main and tail wheel. The main wheel landing brake can then be applied for a shortened ground roll.

In side - slip with airbrakes extended there is vibration of sailplane. The control-stick should be in aft position.

Due to side - slip rudder control force decrease or reversal is possible.

4.5.6 Flight with water ballast

Flight in excess of the maximum gross weight 500 kg is prohibited. The maximum amount of water allowed is dependent on the empty weight of the sailplane combined with the total cockpit load (see Section 6.9).

Warning: If there is a risk of freezing temperatures, all water must be dumped before freezing temperatures are reached. The flight conditions must comply with the following table:

Ground Temperature	C°	10	15	20	30	40
	F°	50	59	68	86	104
Max. flight altitude	m	1200	2000	2700	4300	5800
	ft	4000	6500	9000	14000	19000

Filling and Dumping the Water Ballast: After filling the ballast tanks either full or with partial loads the wings should be levelled and checked for symmetry. Flight with leaking ballast valves is prohibited. Open ballast valves fully to dump water ballast.

A time to drain water ballast tanks:

- wing tanks ~ 4 min 30 sec;
- tail tank ~ 1 min 30 sec.

Warning: A filling ballast tank with pressurized water is prohibited. Always allow space for the displaced air to escape.

4.5.7 High altitude flights

Indicated airspeed readings are progressively under-stated of true airspeed with higher altitudes. Therefore the following limitations apply to high altitude flights:

Altitude, m	V _{NE} indicated, km/h
3000	275
4000	275
5000	260
6000	245
8000	220
10000	195

Special care should be taken to ensure that there is no moisture on any section of the control junctions that could lead to freezing at high altitudes.

4.5.8 Flight in rain

With light rain the stall speed and sink rate increase slightly, therefore landing approach speeds in rain must be increased. Rainwater on wings should be removed before take-off. Do not fly into icing conditions with a wet sailplane.

Section 5

- 5 Performance
- 5.1 Introduction
- 5.2 Data approved by Lithuanian Civil Aviation Administration
 - 5.2.1 Airspeed indicator system calibration
 - 5.2.2 Stall speeds
- 5.3 Additional Information
 - 5.3.1 Demonstrated crosswind components
 - 5.3.2 Glide performance
 - 5.3.3 Flight Polar

5.1 Introduction

This section provides LCAA approved data for airspeed calibration, stall speeds and take-off performance and non-approved further information. The data in the charts have been computed from actual flight tests with the sailplane in good condition and using average piloting techniques.

5.2 Data approved by Lithuanian Civil Aviation Administration

5.2.1 Airspeed indicator system calibration

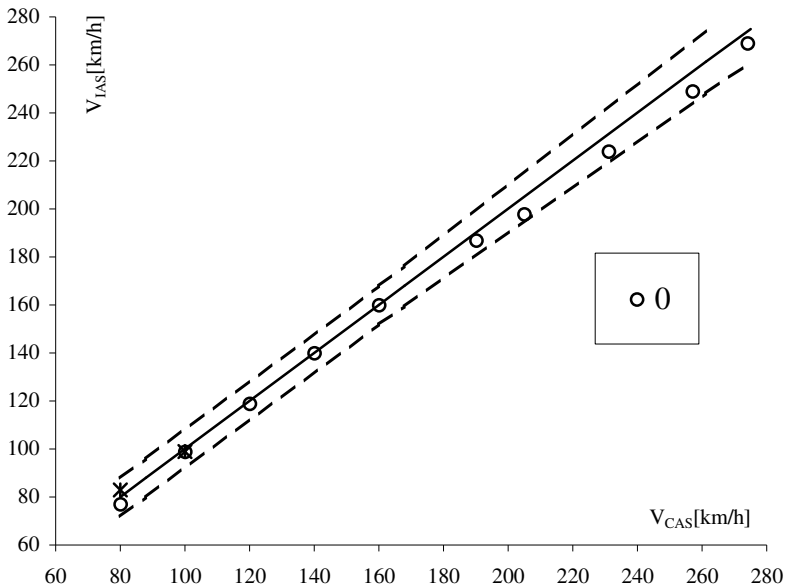

Caution: The airspeed indicator is to be connected to the pitot source from the fuselage nose and static source from the aft fuselage part. Colour coding of the plastic tubing is as follows:

Red - pitot, yellow - tail static, TE tube-green

5.2.2 Stall speeds

Stall speed in level flight, km/h	
without water ballast	with maximum take off weight
82	95

The loss of height for stall recovery is approximately 30 m if recovery is immediate.

5.3 Additional information

5.3.1 Demonstrated crosswind components

The demonstrated crosswind velocity is 4.16 m/s (15 km/h) according to the airworthiness requirements.

5.3.2 Glide performance

Data evaluated by comparison flights.

For optimum performance the aircraft should be flown with a C.G. position between medium and the rear of the allowable range. However, the aircraft will be more pitch sensitive at aft C.G. positions.

The wing fuselage joint and the tailplane locking *pin* should be taped *over* and the aircraft thoroughly cleaned to obtain maximum performance. The polar apply to a clean aircraft. With dirty wings or flight in rain the performance drops accordingly.

5.3.3 Flight polar

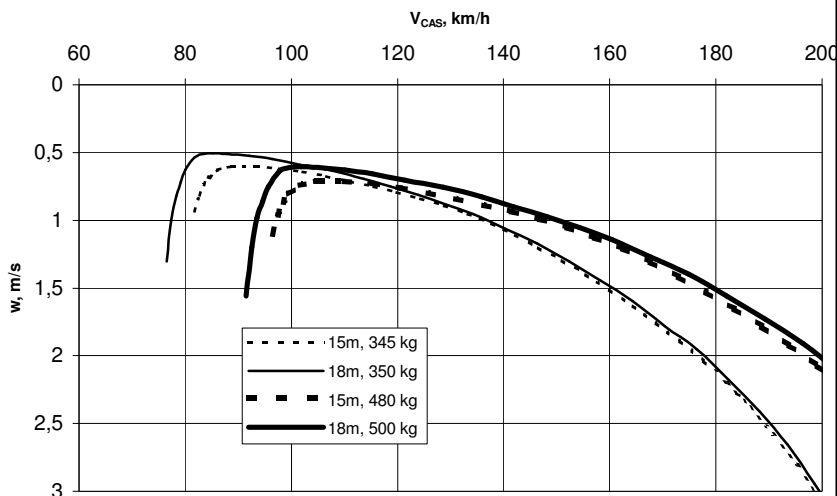

Section 6

- 6. Weight and Balance
- 6.1 Introduction
- 6.2 Weighing procedures
- 6.3 Weighing record
- 6.4 Empty weight and C.G.
- 6.5 Calculation of C.G. position
- 6.6 Weight of all non-lifting parts
- 6.7 Maximum weight
- 6.8 Useful loads
- 6.9 Water ballast loading table

6.1 Introduction

This section contains the payload range within which the sailplane can be safely operated. Procedures for weighing the sailplane and the calculation method for establishing the permitted payload range are also provided. A comprehensive list of all equipment available for this sailplane is contained in the Maintenance Manual.

6.2 Weighing procedures

The Weight and Balance Report for the LAK-19 must be calculated in accordance with the currently valid weighing data. The weighing must be established according following picture

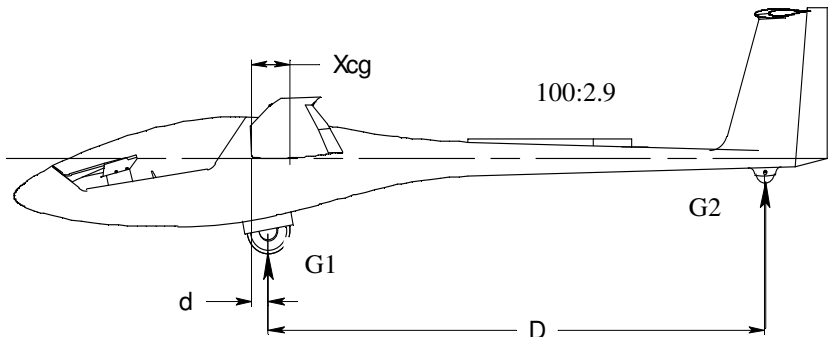

6.3 Weighing record

The result of each C.G. weighing is to be entered in the Weight and Balance Report in Section 6.4. The current minimum cockpit load must also be entered on the cockpit placard. When adding or changing instruments or equipment the new weighing report may be produced by a C.G. calculation using the following formula:

$$X_{cg} = \frac{G2 * D}{G1 + G2} + d, \text{ mm}$$

Warning: Due to flatter reasons it is not allowed to add additional masses to the fin battery or into the battery compartment.

Warning: The vertical tail fin battery (weight 3.5 kg) during flight must be install.

Warning: Due to the possibilities of the comfortable seat adjustment it is possible to fall out of the foremost C.G. position for small but heavy pilots (front seat position). In this case it is not allowed to correct the C.G. position by using fin water ballast, as jettisoning fin water ballast the C.G will fall out of the allowed range.

The battery in luggage taking out move the C.G. of sailplane forward by approximately $2 \div 3$ mm.

Removable ballast used to supplement the weight of an occupant and parachute (when lower than 70 kg) in order to keep C.G. position within limits is fastened in fuselage nose. 1.75kg of removable ballast equals a pilot weight of 5 kg.

The permissible range of centre of gravity position in dependence of glider's empty weight, pilot weight and fin water ballast weight is given below and in the Maintenance Manual, Section 7.

LIMITS OF EMPTY MASS CENTER OF GRAVITY FOR LAK-19

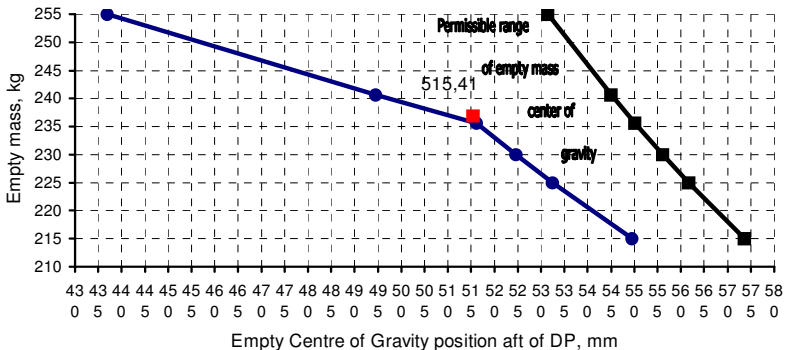

6.5 Calculation of C.G. position

Centre of gravity position after loading glider (additional instruments, equipment, water ballast, pilot) is defined by:

$$X_{CG} = \frac{\sum_n G_n * X_n}{\sum_n G_n}, \text{ mm}$$

Where: G_n = the gliders component mass, kg;

X_n = distance between glider components masses C.G. and wing root leading edge, mm;

distance “-“, if mass C.G. is before wing root leading edge;

distance “+” if mass C.G. is behind wing root leading edge;

n = number of glider components masses;

ΣG_n = sum of all glider components masses;

$\Sigma G_n * X_n$ = sum moments of all glider components masses;

The C.G. calculation table

No	Component	Weight G_n kg	Distance X_n mm	Moment $G_n * X_n$ kg * mm
1.	Empty glider			
2.	Pilot			
3.	Battery in baggage compartment	2.6	520	
4.	Water ballast in wings		168	
5.	Water ballast in fin		4003	
6.	Instrument N1 in instrument panel		-1010	
7.	Instrument N2 in instrument panel			
8.				
9				
-				
n-1	Removable ballast in fuselage nose	(1÷5)	-1785	
n	Baggage weight		150	
$\Sigma G_n =$			$\Sigma G_n * X_n =$	

$$X_{CG} = \frac{\sum_n G_n * X_n}{\sum_n G_n}, \text{ mm}$$

Note:

- The glider empty weight and empty weight center of gravity are defined by weighting data.
- Pilot: real pilot weight with parachute,
distance $X = -520$, when pilot seat in rearmost position;
distance $X = -670$, when pilot seat in foremost position .
- Water ballast in wings: really filled water ballast weight.
- Water ballast in fin: really filled water ballast in fin tank weight.
- Baggage weight: baggage in baggage compartment weight .

6.6 Weight of all non-lifting parts

The maximum approved weight of all non-lifting parts is 233 kg.

The actual weight of all non-lifting parts is equal to the empty weight, plus the weight of the cockpit load (Pilot, Parachute, etc.), minus the weight of the wings.

6.7 Maximum weight

The maximum approved take-off and landing weight is 480 kg for 15 m wing and 500 kg for 18 m wing.

6.8 Useful loads

The maximum useful load of the LAK-19 is equal to the maximum approved take-off and landing weight minus the empty weight of the aircraft plus the weight of any added water ballast.

6.9 Water ballast loading table

The max permissible wing water ballast weight (kg) is given in the following tables.

Wing 15 m

Maximum take-of mass 480 kg

Mass of pilot with parachute	Sailplane empty weight (kg) + fin ballast weight (kg)						
	220	225	230	235	240	245	250
70	180	180	180	175	170	165	160
75	180	180	175	170	165	160	155
80	180	175	170	165	160	155	150
85	175	170	165	160	155	150	145
90	170	165	160	155	150	145	140
95	165	160	155	150	145	140	135
100	160	155	150	145	140	135	130
105	155	150	145	140	135	130	125
110	150	145	140	135	130	125	120

Wing 18 m

Maximum take-of mass 500 kg

Mass of pilot with parachute	Sailplane empty weight (kg) + fin ballast weight (kg)						
	220	225	230	235	240	245	250
70	180	180	180	180	180	180	180
75	180	180	180	180	180	180	175
80	180	180	180	180	180	175	170
85	180	180	180	180	175	170	165
90	180	180	180	175	170	165	160
95	180	180	175	170	165	160	155
100	180	175	170	165	160	155	150
105	175	170	165	160	155	150	145
110	170	165	160	155	150	145	140

Maximum capacity of wing tanks.....180 liter

Maximum capacity of fin tank.....8 liter.

Example:

Sailplane empty weight.....236.9 kg
Empty weight center of gravity.....515.4 mm
Pilot with parachute weight.....80 kg
Wing span.....18 m

According graph “Limits of empty mass center of gravity for LAK-19” (page 6.5) - empty weight C.G. is in permissible range.

According graph “Allowed fin water ballast for pilot mass of 80 kg” (page 6.13) – allowed fin water ballast weight is 0 ÷ 4 kg.

If:

- fin water ballast weight is 4 kg,
- sailplane empty weight +fin ballast weight =236.9+4=240.9 ≈241 kg,
- pilot with parachute weight=80 kg,

according “Water ballast loading table” (page 6.9) - the max permissible wing water ballast weight is ≈179 kg.

Warning:

Due to the possibilities of the comfortable seat adjustment it is possible to fall out of the foremost C.G. position for small but heavy pilots (front seat position). In this case it is not allowed to correct the C.G. position by using fin water ballast, as jettisoning fin water ballast the C.G will fall out of the allowed range.

SAILPLANE LAK-19 EMPTY CENTRE OF GRAVITY

Pilot weight 70 kg

Aft limit for fin tank water ballast

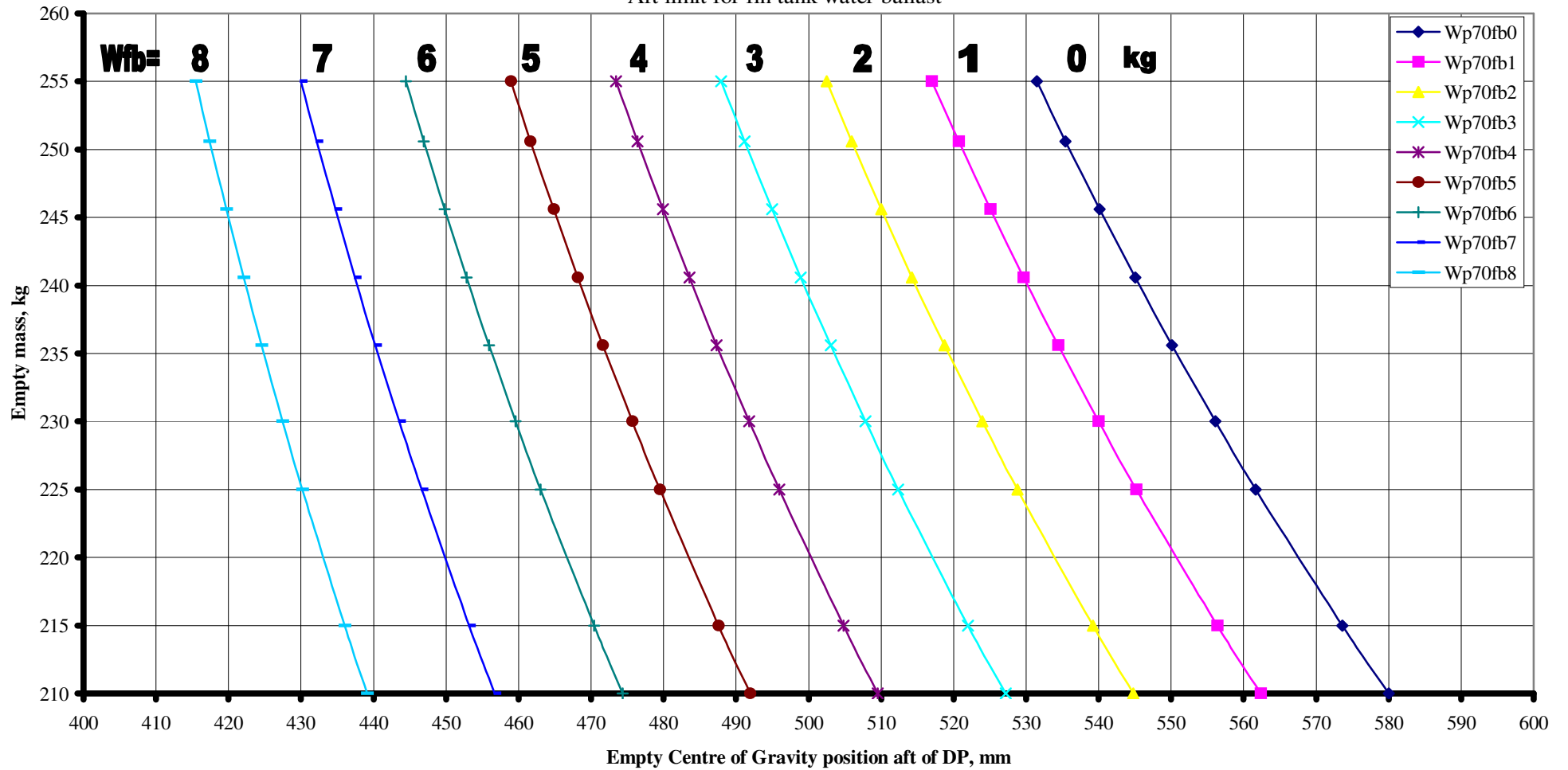

SAILPLANE LAK-19 EMPTY CENTRE OF GRAVITY

Pilot weight 75 kg

Aft limit for fin tank water ballast

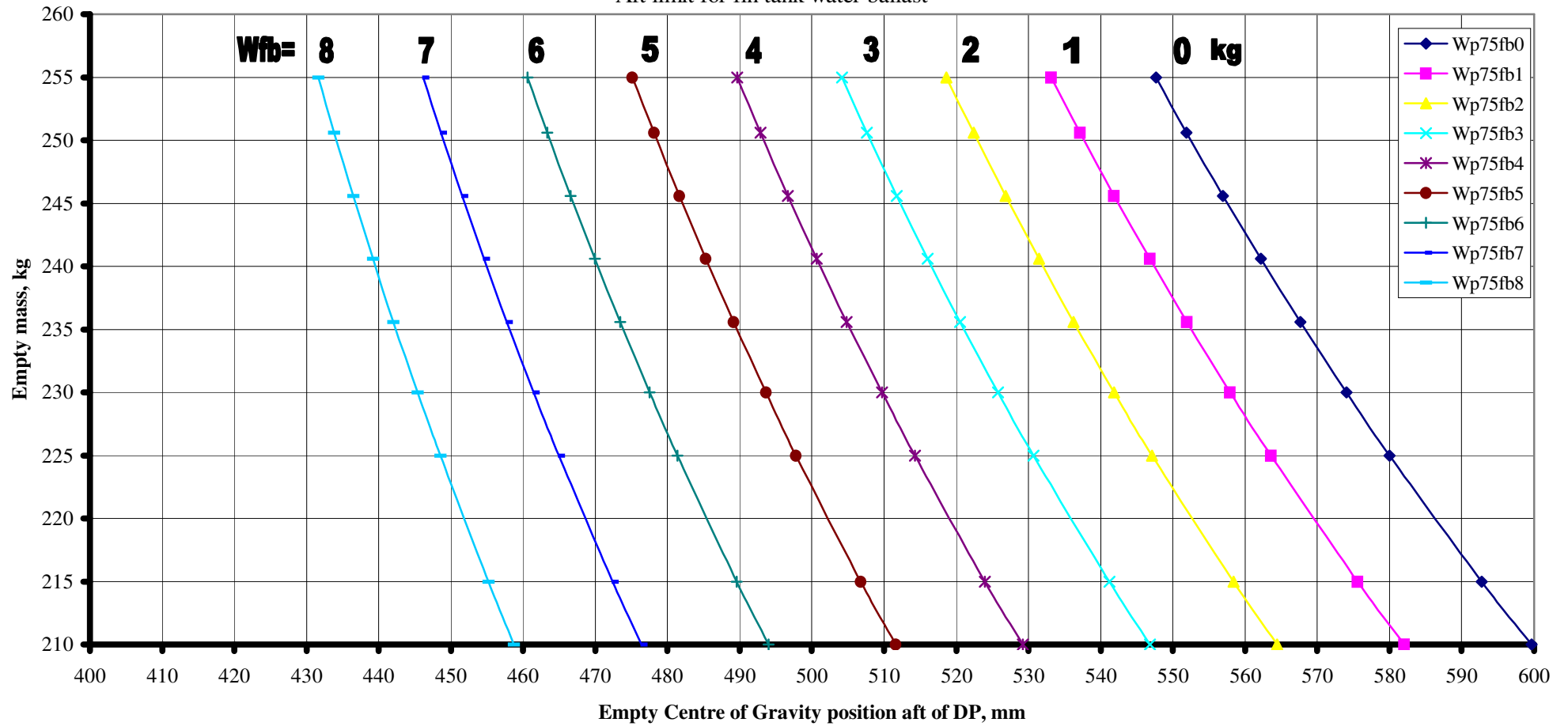

SAILPLANE LAK-19 EMPTY CENTRE OF GRAVITY

Pilot weight 80 kg

Aft limit for fin tank water ballast

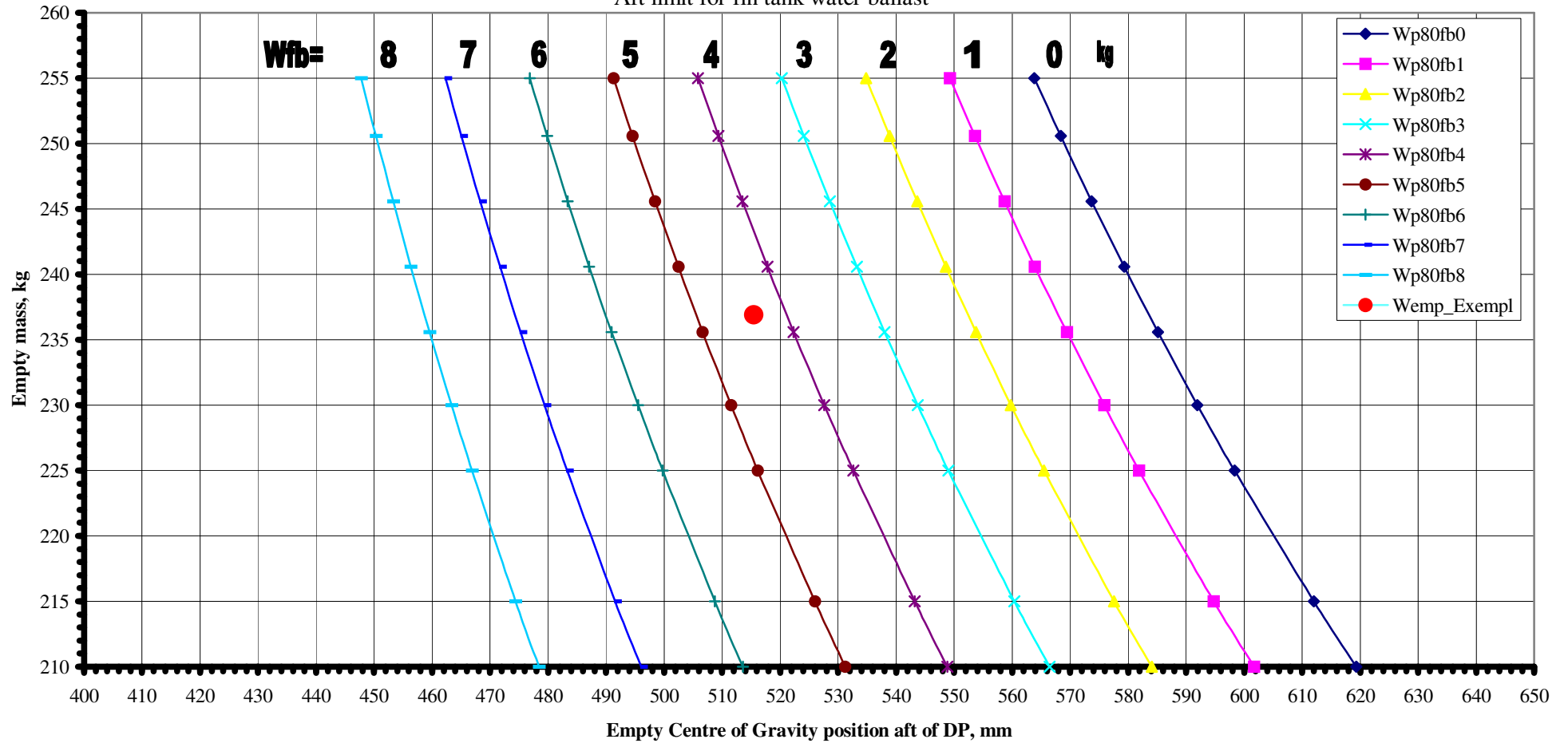

SAILPLANE LAK-19 EMPTY CENTRE OF GRAVITY

Pilot weight 85 kg

Aft limit for fin tank water ballast

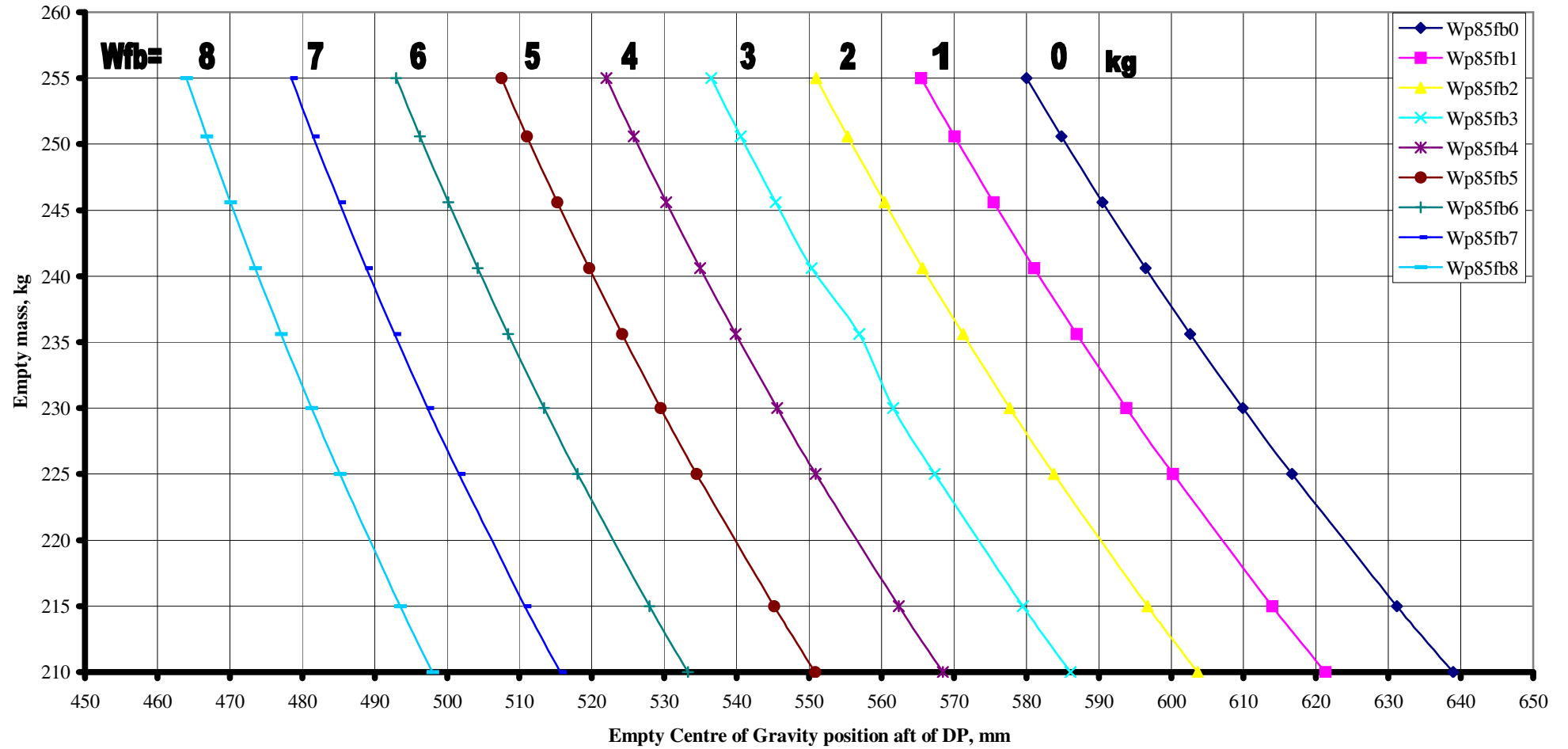

SAILPLANE LAK-19 EMPTY CENTRE OF GRAVITY

Pilot weight 90 kg

Aft limit for fin tank water ballast

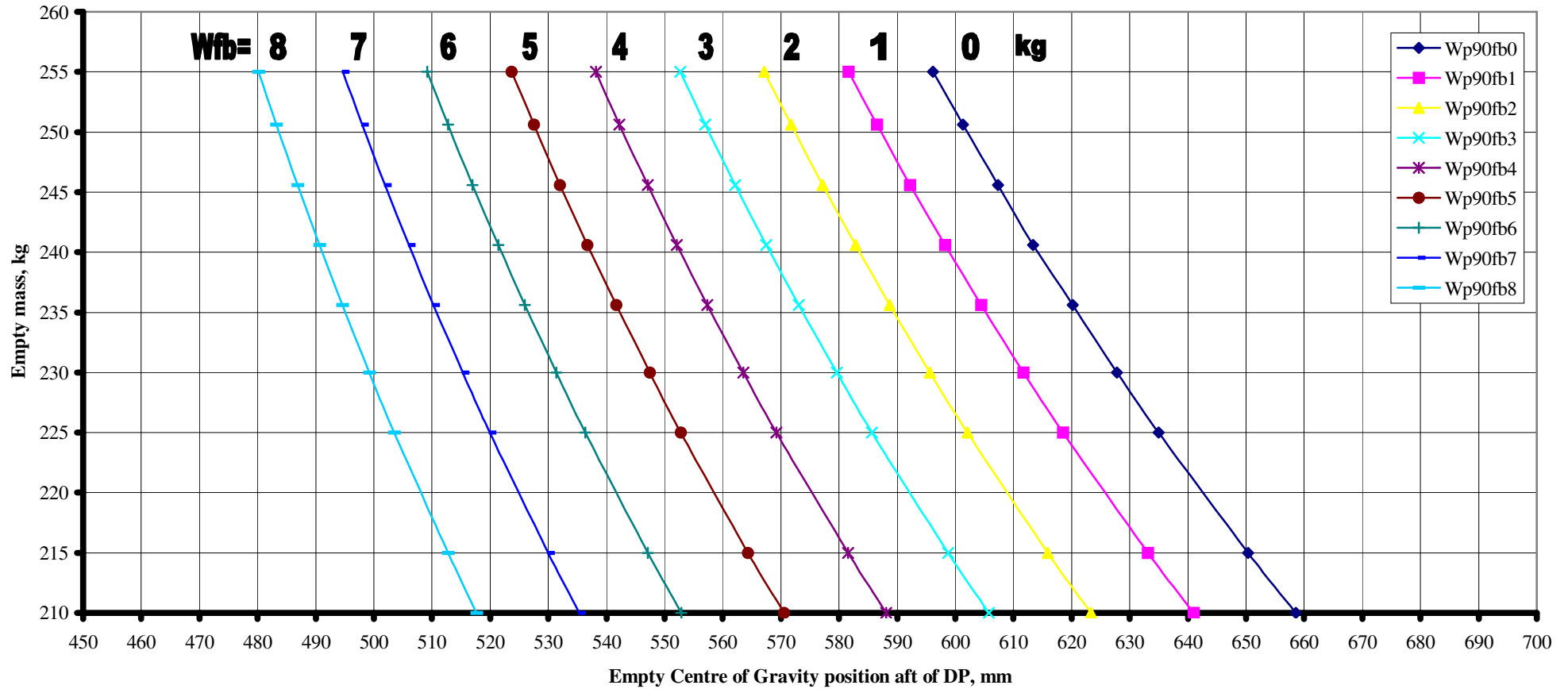

SAILPLANE LAK-19 EMPTY CENTRE OF GRAVITY

Pilot weight 95 kg

Aft limit for fin tank water ballast

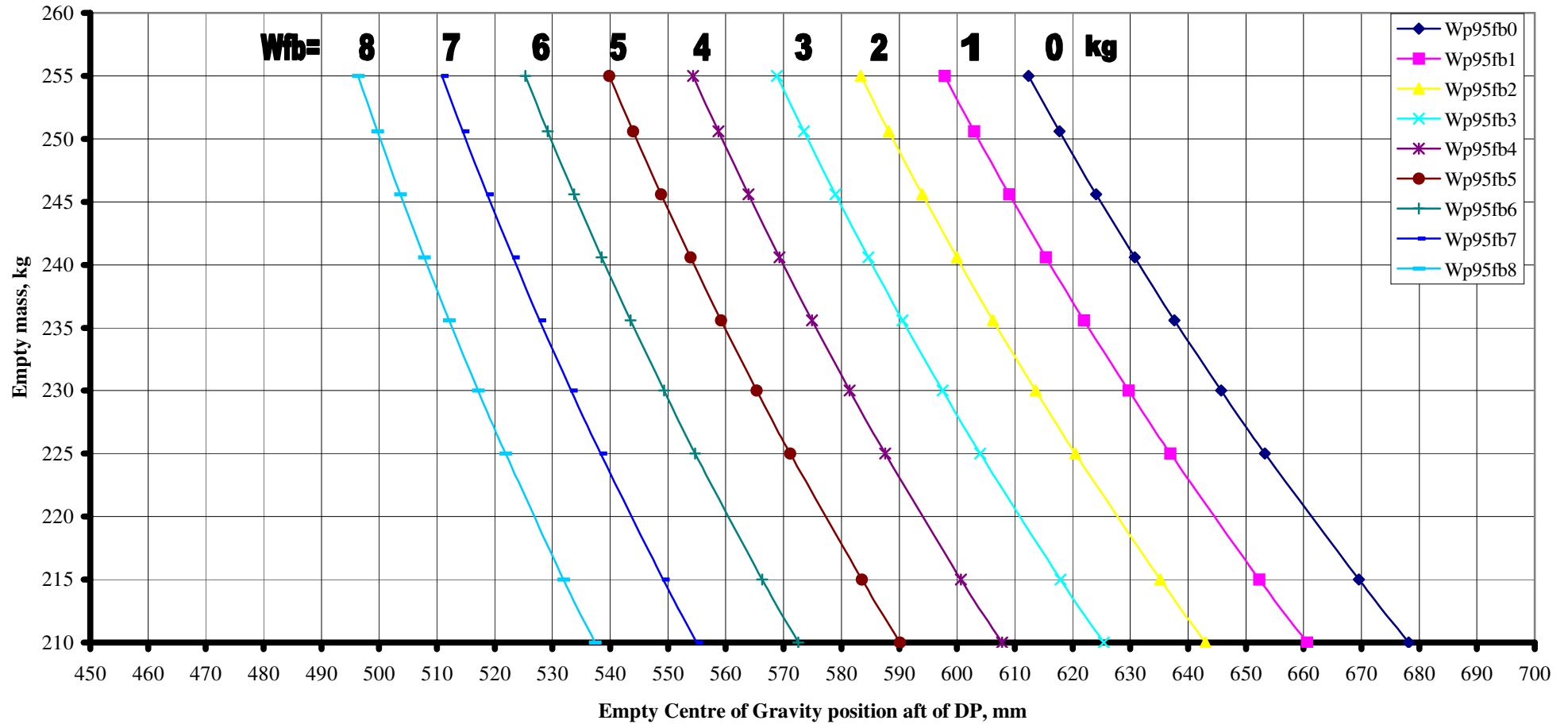

SAILPLANE LAK-19 EMPTY CENTRE OF GRAVITY

Pilot weight 100 kg

Aft limit for fin tank water ballast

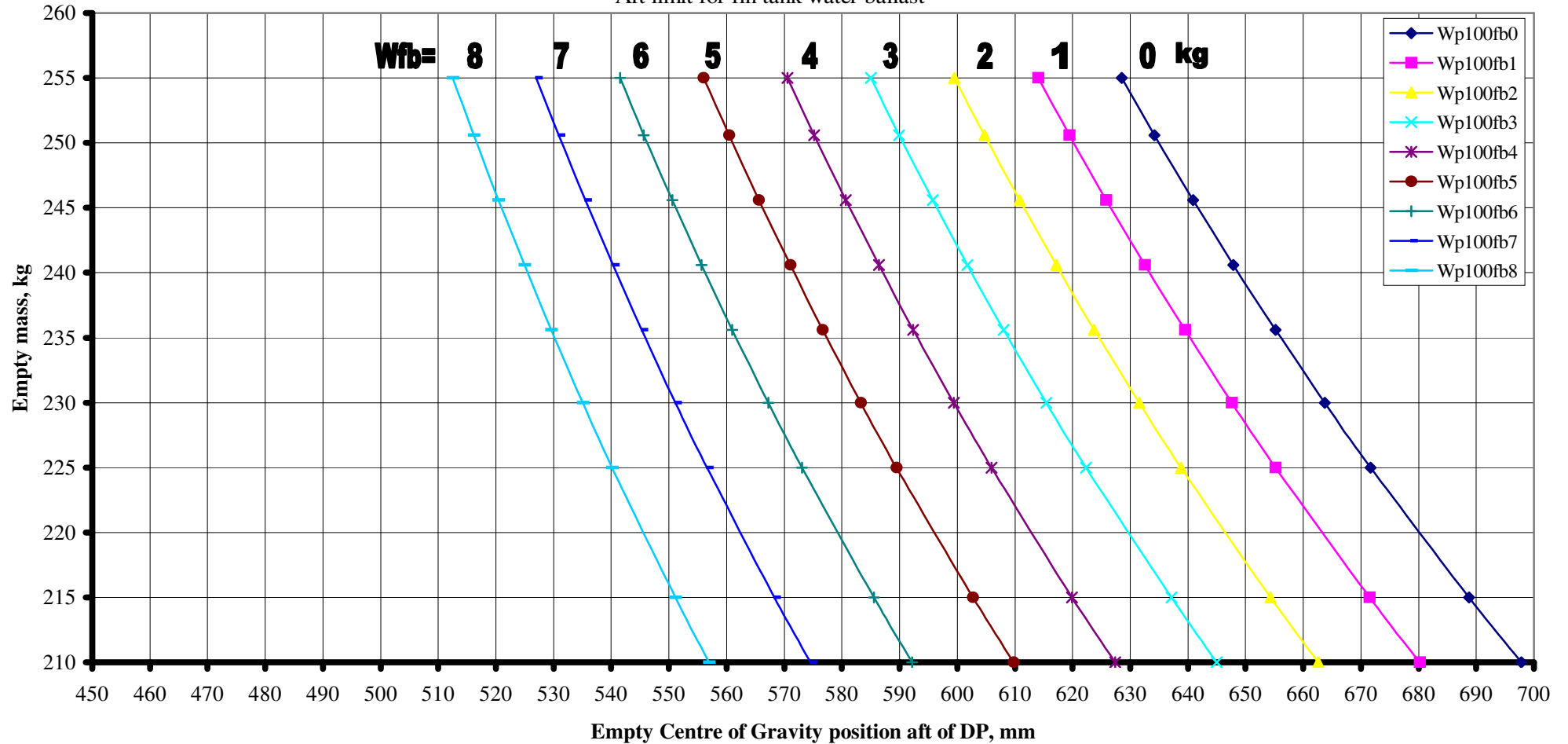

SAILPLANE LAK-19 EMPTY CENTER OF GRAVITY

Pilot weight 105 kg

Aft limit for fin tank water ballast

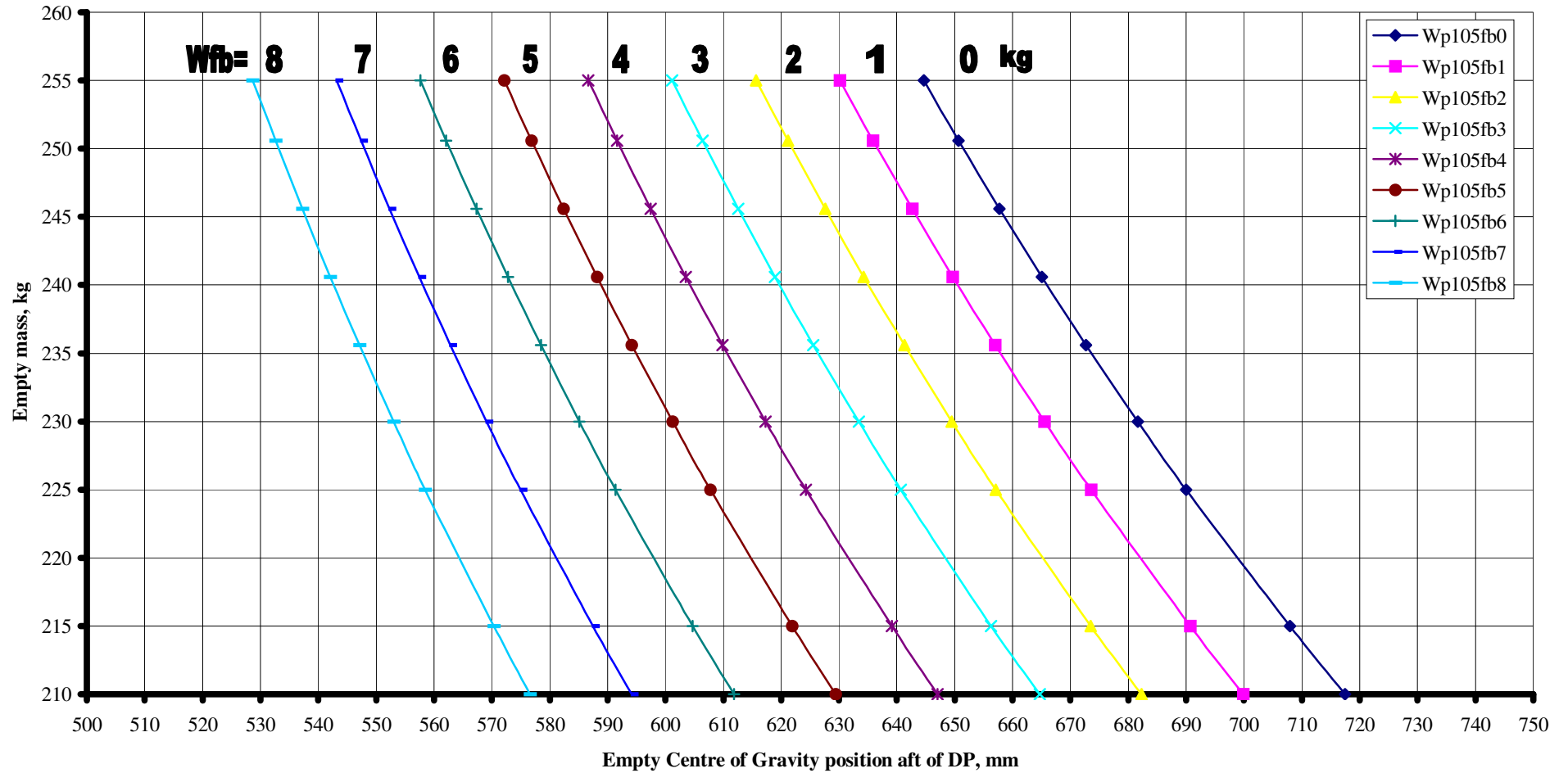

SAILPLANE LAK-19 EMPTY CENTRE OF GRAVITY

Pilot weight 110 kg

Aft limit for fin tank water ballast

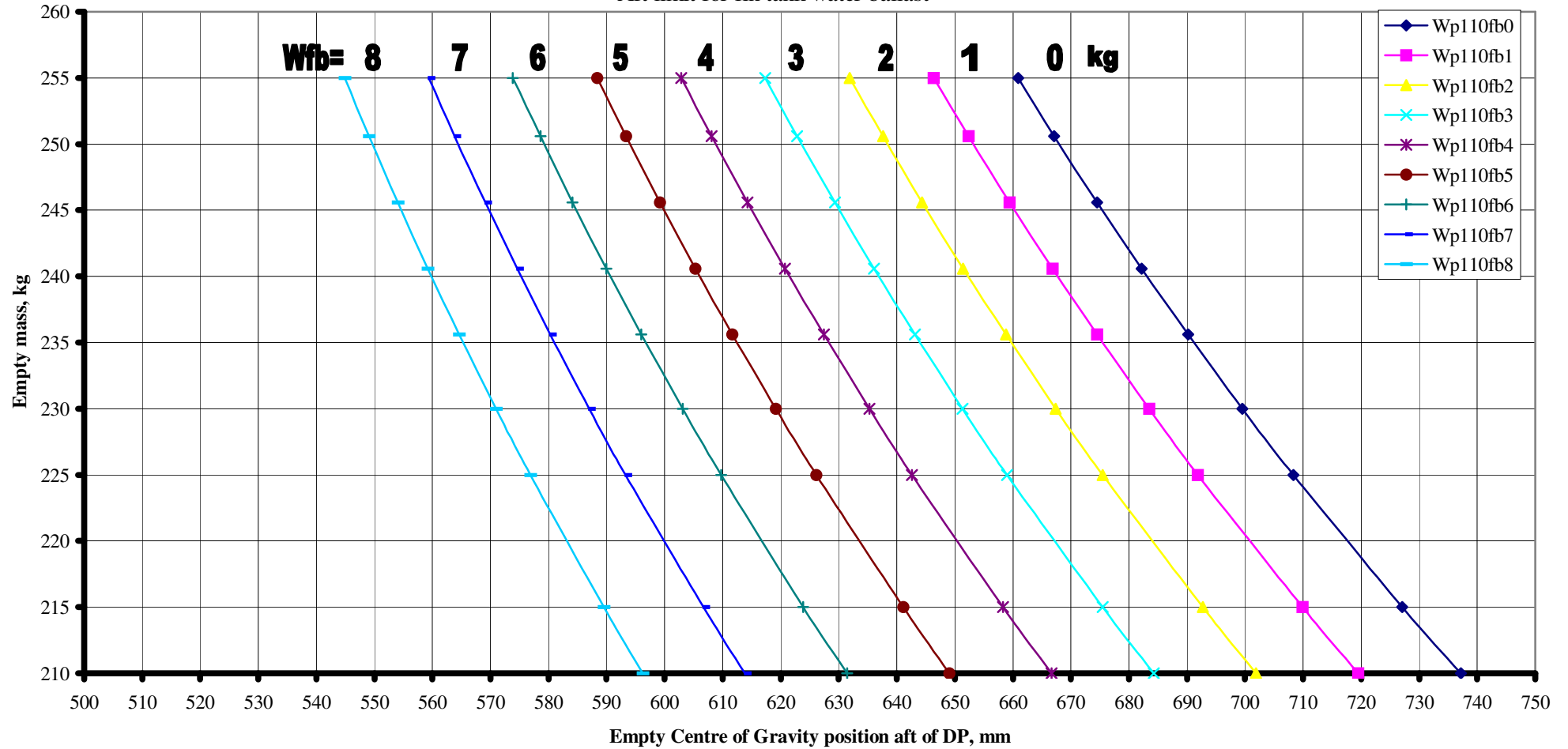

Section 7

- 7. Description of the sailplane and systems
 - 7.1 Introduction
 - 7.2 Airframe construction
 - 7.3 Flight controls and trim
 - 7.4 Airbrakes and wheel brake
 - 7.5 Landing gear
 - 7.6 Tow release
 - 7.7 Canopy operation
 - 7.8 Water ballast system
 - 7.9 Cockpit ventilation
 - 7.10 Seat back adjustment
 - 7.11 Baggage compartment
 - 7.12 Safety harness
 - 7.13 Pitot and static pressure system
 - 7.14 Miscellaneous equipment
 - 7.14.1
 - 7.14.2
 - 7.15 Radio station

7.1 Introduction

This Section provides a description of the sailplane, its systems and provided standard equipment with instructions for use.

7.2 Airframe construction

The LAK-19 is a single seat high performance sailplane designed to meet FAI Standard Class requirements. The wings are constructed with glass and carbon fibre reinforced plastic over a plastic foam core with carbon rod spar caps. The ailerons are from carbon fibre reinforced plastics. The fuselage is made using glass fibre reinforced plastic with Kevlar and carbon for local stiffness. The stabilizer, elevator and rudder are glass fibre reinforced plastics over plastic foam core.

7.3 Flight controls and trim

The ailerons and elevator are operated from the centre control column. Additionally the trim adjustment control knob located *in the left armrest* controls the elevator trim select position. See Maintenance Manual Section 2. To set the trim simply moves the adjustment knob to the desired trim position.

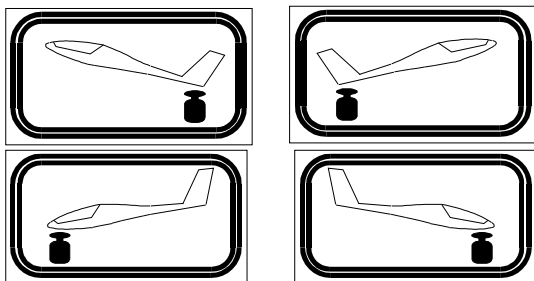

*check direction of
arrow*



The rudder pedals control the rudder by a cable system and are adjusted using the grey knob located in the right arm rest. Pull the knob to loosen the rudder pedal lock, make the adjustment, and release the knob to lock the rudder pedals in the desired position.

7.4 Airbrakes and wheel brake

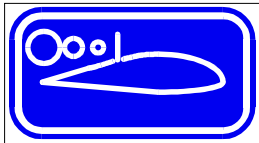
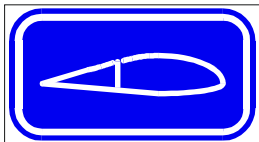

The airbrakes are operated by the blue control handle located on the left cockpit wall. Pull the handle back to extend the airbrakes and push forward to retract and lock.

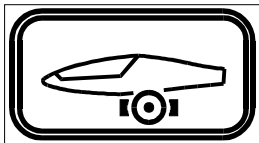

The wheel brake is actuated via the handle of airbrakes. See Maintenance Manual Section 2. The mechanical wheel brake system is optional. The main wheel brake is controlled by a handle arranged on the control stick.

7.5 Landing gear

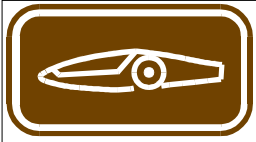
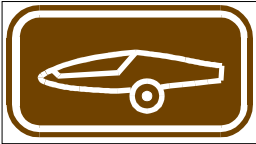

The landing gear is extended and retracted with the black control handle located in the right hand armrest. Landing gear locked positions are located at the beginning either end of the control handle travel. Forward to extend, back to retract. The system is assisted by a nitrogen gas strut. See Maintenance Manual Section2.

7.6 Tow release

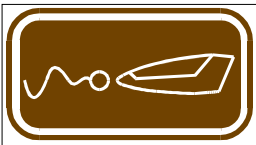

The tow release is the yellow control knob located at the left side wall of the cockpit. Pull this control knob to open the tow release and release the knob to allow the tow coupling to snap closed and lock.

7.7 Canopy operation

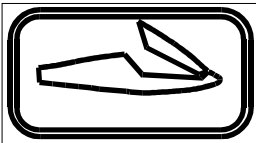

The canopy latching handles are red and white and are located on either side of the canopy frame. Pull the handles back to lock and push forward to un-lock. Never use the window opening to lift or lower the canopy. Cracks in the canopy will result.

When sitting in the cockpit use the small tabs on the frame to raise and lower the canopy.

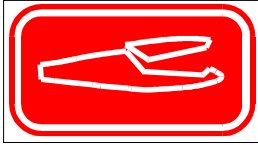

To jettison the canopy pull the red canopy release handles firmly back then let go of it. A spring will push the front of the canopy up. This allows the airflow to lift it up and carry it away.

7.8 Water ballast system

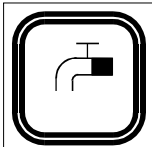

The tank valves for wing and tail is open simultaneously with one knob.

The water ballast valves control knob of tanks is located on the right side of the cockpit wall. To open the dump valves move the knob to the back and to close the dump valves move the knob to the forward.



(If the sailplane has independent fin tank valve control system - the water ballast valve control knob of fin tank is located on the right side of the cockpit wall. To open the dump valves move the knob to the back and to close the dump valves move the knob to the forward).

See Maintenance Manual Section 2.

7.9 Cockpit ventilation



The canopy de-mist vent control is located on the instrument panel. Pull to open, push to close.

7.10 Seat back adjustment

Seat back adjustment is accomplished by using the squeeze ring located on the left cockpit side.

7.11 Baggage compartment

Hard objects can not be carried in the baggage compartment without a suitably designed lashing or anchorage. The baggage compartment load must not exceed 7 kg.

7.12 Safety harness

A safety harness with four fixed attachment points is provided.

7.13 Pitot and static pressure system

The fuselage-mounted tubes provide the pitot and static pressure.

Warning: An air leak will adversely affect airspeed indication and other instruments. Make sure the probe is fully seated in the receptacle for proper operation.

See Maintenance Manual Section 2.

7.14 Miscellaneous equipment

7.14.1 Oxygen system

The oxygen system (Aerox Oxygen, type E or M) must be operated in accordance with the instructions provided by the manufacturer (Aerox Oxygen, type E or M) of the system.

Caution: Installation of the oxygen system (Aerox Oxygen, type E or M) must be accomplished by the aircraft manufacturer or by a certified aircraft mechanic, according to national rules and regulations. A authority aircraft inspector must approve the installation.

7.14.2 Emergency locator transmitter

See the Maintenance Manual for the approved installation plan. The system must be operated in accordance with the instructions provided by the manufacturer of the Emergency Locator Transmitter system.

Caution: Installation of the Emergency Locator Transmitter must be accomplished by the aircraft manufacturer or by a certified aircraft mechanic, according to national rules and regulations. A authority aircraft inspector must approve the installation.

7.15 Radio station

The radio station of type Becker or Filser should be used

Section 8

- 8. Sailplane handling, care and maintenance
 - 8.1 Introduction
 - 8.2 Inspection periods and maintenance
 - 8.3 Alterations and repairs
 - 8.4 Tie down
 - 8.5 Sailplane trailer
 - 8.6 Ground handling
 - 8.7 Cleaning

8.1 Introduction

This section contains the manufacturer's recommended procedures for proper handling and servicing of the sailplane. It also identifies certain inspection and maintenance activities, which are needed to retain performance and dependability.

8.2 Inspection periods and maintenance

The Instructions for Continued Airworthiness as provided in the LAK-19 Maintenance Manual must be followed. Before each rigging, all connecting pins and bushings should be cleaned and greased. Also, at least once a year the control surface displacements and adjustments must be inspected to insure conformity with factory data. See the LAK-19 Maintenance Manual for additional information.

8.3 Alterations and repairs

It is essential that the proper airworthiness authority be contacted prior to any major alterations on this sailplane to insure that the airworthiness is not impaired. Major alterations without approval from the manufacturer are prohibited. Furthermore, the manufacturer will not be held liable for unproved alterations or for damages resulting from changes in the characteristics of the aircraft due to these alterations. External loads from camera installations are to be regarded as major alterations. Repair instructions are located in the Maintenance Manual Section 8. No repair should be performed to this aircraft without referring to Maintenance Manual. When in doubt as to the suitability of a repair contact the manufacture.

Caution: No additional colour marking on the white upper surface is allowed.

8.4 Tie down

The recommended tie down points are the tow release, wing tips and fuselage tail just ahead of the vertical fin. The cockpit always must be closed and covered when tied down.

Note: The external surfaces of the LAK-19 are finished in a durable epoxy paint , however long exposure to sun and humidity will lead to premature aging to any surface finish.

8.5 Sailplane trailer

A sailplane of this quality and value should be transported and stored in a high quality enclosed trailer constructed of metal or fiber glass reinforced plastics. Proper ventilation and UV blocking characteristics should be provided. The wings should be supported as close as possible to the inner most root rib and again at a point one third from the wing tip. The horizontal stabilizer may be stored vertically or horizontally. The fuselage should be supported in a fuselage dolly positioned just forward of the main landing wheel opening. Due to the angle of the fuselage in the trailer a forward stop must be provided for the fuselage dolly. Otherwise it will roll forward and leave the fuselage with no support. Forward and aft motion of the fuselage should be restricted with a felt lined nose cone support and a tail wheel well with a fuselage strap located just forward of the vertical fin.

8.6 Ground handling

Ground towing should be accomplished using the tow release and standard double aerotow ring. Ground towing should also be accomplished with a tail dolly tow bar and wing tip wheel.

8.7 Cleaning

The exterior painted surfaces should be cleaned with clear water using a sponge or soft cotton towel and chamois. These surfaces should also be protected with a silicone free hard wax reapplied at least once a year by hand or with a rotating cloth disc. Tape adhesives are best removed using pure petroleum spirits or wax containing a light polishing agent. Do not clean the exterior surfaces with alcohol, acetone or lacquer thinner.

Clean the Plexiglas canopy only as necessary using a soft cotton towel and clear water mixed with a small amount of mild detergent. Protect the canopy with anti-static cleaning agents which are made specifically for Plexiglas.

All non-painted metal surfaces must be regularly wiped clean and protected with a light coating of grease.

Section 9**There is no supplements**