

## FLIGHT MANUAL

for the

**self-sustaining powered sailplane**

**LAK-17BT**

Model: LAK-17BT

Serial Number:

Registration: \_\_\_\_\_

Date of Issue: \_\_\_\_\_

It is a preliminary manual. The sailplane is not certified and has not shown compliance with airworthiness requirements.

This sailplane is to be operated in compliance with the regulatory information and limitations contained herein.

**This Manual should always be kept on board of the sailplane**



**0.1 Record of revisions**

Any revision of the present manual, except actual weighing data, must be recorded in the following table and in the case of approved Chapters, endorsed by the responsible airworthiness authority.

The new or amended text in the revised page will be indicated by a black vertical line in the left hand margin, and the revision number and date will be shown on the bottom left hand of the page.

Rev. No.	Affected Chapter	Affected Pages	Date of Issue	Approval	Date of approval	Date of Insertion	Signature

Intentionally left blank

**0.2 List of effective pages**

Chapter	Page	Date of Issue	Chapter	Page	Date of Issue
0	i	02 March 2009		Appr. 4-5	02 March 2009
	ii	02 March 2009		Appr. 4-6	02 March 2009
	iii	02 March 2009		Appr. 4-7	02 March 2009
	iv	02 March 2009		Appr. 4-8	02 March 2009
	v	02 March 2009		Appr. 4-9	02 March 2009
	vi	02 March 2009		Appr. 4-10	02 March 2009
				Appr. 4-11	02 March 2009
1	1-1	02 March 2009		Appr. 4-12	02 March 2009
	1-2	02 March 2009		Appr. 4-13	02 March 2009
	1-3	02 March 2009		Appr. 4-14	02 March 2009
	1-4	02 March 2009			
	1-5	02 March 2009	5	5-1	02 March 2009
	1-6	02 March 2009		Appr. 5-2	02 March 2009
				Appr. 5-3	02 March 2009
2	2-1	02 March 2009		Appr. 5-4	02 March 2009
	Appr. 2-2	02 March 2009			
	Appr. 2-3	02 March 2009	6	6-1	02 March 2009
	Appr. 2-4	02 March 2009		6-2	02 March 2009
	Appr. 2-5	02 March 2009		6-3	02 March 2009
	Appr. 2-6	02 March 2009		6-4	02 March 2009
	Appr. 2-7	02 March 2009		6-5	02 March 2009
	Appr. 2-8	02 March 2009		6-6	02 March 2009
	Appr. 2-9	02 March 2009		6-7	02 March 2009
	Appr. 2-10	02 March 2009		6-8	02 March 2009
				6-9	02 March 2009
3	3-1	02 March 2009		6-10	02 March 2009
	Appr. 3-2	02 March 2009		6-11	02 March 2009
	Appr. 3-3	02 March 2009		6-12	02 March 2009
	Appr. 3-4	02 March 2009		6-13	02 March 2009
	Appr. 3-5	02 March 2009		6-14	02 March 2009
	Appr. 3-6	02 March 2009			
			7	7-1	02 March 2009
4	4-1	02 March 2009		7-2	02 March 2009
	Appr. 4-2	02 March 2009		7-3	02 March 2009
	Appr. 4-3	02 March 2009		7-4	02 March 2009
	Appr. 4-4	02 March 2009		7-5	02 March 2009

Continued

Chapter	Page	Date of Issue	Chapter	Page	Date of Issue
	7-6	02 March 2009			
	7-7	02 March 2009			
	7-8	02 March 2009			
	7-9	02 March 2009			
	7-10	02 March 2009			
	7-11	02 March 2009			
	7-12	02 March 2009			
	7-13	02 March 2009			
	7-14	02 March 2009			
	7-15	02 March 2009			
	7-16	02 March 2009			
8	8-1	02 March 2009			
	8-2	02 March 2009			
	8-3	02 March 2009			
	8-4	02 March 2009			
9	9-1	02 March 2009			

**Table of contents**

	Chapter
<b>GENERAL</b> (a non-approved chapter).....	1
<b>LIMITATIONS</b> (an approved chapter).....	2
<b>EMERGENCY PROCEDURES</b> (an approved chapter).....	3
<b>NORMAL PROCEDURES</b> (an approved chapter).....	4
<b>PERFORMANCE</b> (a partly approved chapter).....	5
<b>WEIGHT AND BALANCE / EQUIPMENT LIST</b> (a non-approved chapter).....	6
<b>SAILPLANE AND SYSTEMS DESCRIPTION</b> (a non-approved chapter).....	7
<b>SAILPLANE HANDLING, CARE AND MAINTENANCE</b> (a non-approved chapter).....	8
<b>SUPPLEMENTS</b> (a non-approved chapter).....	9

Intentionally left blank



## Chapter 1 GENERAL

1.1	Introduction.....	1-2
1.2	Certification basis .....	1-2
1.3	Warnings, cautions and notes.....	1-2
1.4	Descriptive data .....	1-3
1.5	Three-view drawing .....	1-5
1.6	Abbreviations.....	1-6
1.7	Unit conversions .....	1-6

## 1.1 Introduction

The sailplane flight manual has been prepared to provide pilots and instructors with information for the safe and efficient operation of the LAK-17BT - the self-sustaining sailplane.

This manual includes the material required to be furnished to the pilot by CS-22. It also contains supplemental data supplied by the sailplane manufacturer.

## 1.2 Certification basis

This type of sailplane has been designed in accordance with CS 22 Certification Specifications for Sailplanes and Powered Sailplanes, decision No.2003/13/RM of the Executive director of the agency of 14 November 2003.

Category of Airworthiness: Utility.

## 1.3 Warnings, cautions and notes

The following definitions apply to warnings, cautions and notes used in the flight manual.

**Warning:** *Means that the non-observation of the corresponding procedure leads to an immediate or important degradation of the flight safety.*

**Caution:** *Means that the non-observation of the corresponding procedure leads to a minor or to a more or less long term degradation of the flight safety.*

**Note:** *Draws the attention on any special item not directly related to safety by which is important or unusual.*

## 1.4 Descriptive data

The LAK-17BT is a modification of the single seat high performance self-sustaining powered sailplane of FAI 15m - 18m class LAK-17AT designed according to JAR-22, category "U" specifications. It is a mid-wing self-sustaining glider with flaps, T-tail, retractable main landing gear and water ballast tanks of 188 ltr /49,6 US gal capacity (inner wings-158 ltr / 41,7 US gal, outer wings- 30 ltr / 7,9 US gal). The inner wing water ballast is filled in and poured out through the holes at the bottom of the inner wings. The outer wing water ballast is filled in through the hole in the end rib poured out through the hole at the bottom of the outer wing. Sailplane is equipped with retractable power-plant powered by 19,6 kW (26,28 hp) two stroke two cylinder air cooled SOLO 2350 engine and LAK-P4-90 fixed pitch propeller. Power-plant is started by decompressing and than wind milling, and has no throttle control.

The sailplane is made of hybrid composite materials (Kevlar, carbon and fiberglass). The wing spar is made of modern carbon rods GRAPHLITE SM315 and has a double T section. The airbrakes are located on the upper wing surface only. The wing airfoils:

18m-

s (m)	c (m)	Profile
0.0	0.741	LAP7-150
1.2	0.711	LAP7-131/17
4.6	0.625	LAP7-131/17
6.5	0.5	LAP7-129/18
8.0	0.38	LAP7128/19
8.855	0.226	LAP93/148

15m-

s (m)	c (m)	Profile
0.0	0.741	LAP7-150
1.2	0.711	LAP7-131/17
4.6	0.625	LAP7-131/17
6.7	0.38	LAP7-128/19
7.355	0.226	LAP93/148

The cockpit is of monocoque construction. The manually controlled seat back and an adjustable head rest together with optimally arranged controls offer notable comfort for the long flights. The one piece Plexiglas canopy hinges forward. On the left side there is a sliding window for additional ventilation. The instrument panel folds up together with a canopy.

The retractable landing gear with shock absorbers has a 5.00-5 6PR ply tire. The mechanical main wheel brake is actuated via the handle on the stick. The rudder pedals are adjustable in flight. All controls, including the water ballast system, hook up automatically or semi-automatically. Towing hooks are mounted: near the main landing gear (C.G. / winch / auto-tow hook) and/or in front of the pilot cockpit at the bulkhead (aero tow hook). Both towing hooks are operated by the same handle. The wings incorporate fork-type spar tips, joined with two pins.

The T-tail (fixed stabilizer with elevator) of the LAK-17BT provides stable and responsive pitch characteristics. The elevator hooks up automatically during assembly. The glider is fitted with a fin ballast tank of 8 ltr (2,11 US gal) capacity in order to adjust the optimum C.G. position. The antenna is mounted in the vertical fin.

Engine parameters are controlled by the instrument of type ILEC MCU LAK-17BT. Power-plant extraction/retraction is operated automatically with the extract/retract switch located on the MCU. Electronic safety devices are provided to avoid misoperation.

### Technical data of the LAK-17BT

Wing span	15 m (49,2 ft)	18 m (59,06 ft)
Fuselage length	6,53 m (21,42 ft)	
Height	1,29 m (4,23 ft)	
Max gross weight	550 kg (1212,5 lbs)	600 kg (1322,8 lbs)
Mean aerodynamic chord	0,6281 m (24,73 in)	0,6072 m (23,905 in)
Wing area	8,95 m <sup>2</sup> (96,34 ft <sup>2</sup> )	10,32 m <sup>2</sup> (111,08 ft <sup>2</sup> )
Wing loading:		
minimum	41,5 kg/m <sup>2</sup> (8,5 lbs/ft <sup>2</sup> )	36.47 kg/m <sup>2</sup> (7,47 lbs/ft <sup>2</sup> )
maximum	61,45 kg/m <sup>2</sup> (12.58 lbs/ft <sup>2</sup> )	58.13 kg/m <sup>2</sup> (11,90 lbs/ft <sup>2</sup> )

## 1.5 Three-view drawing

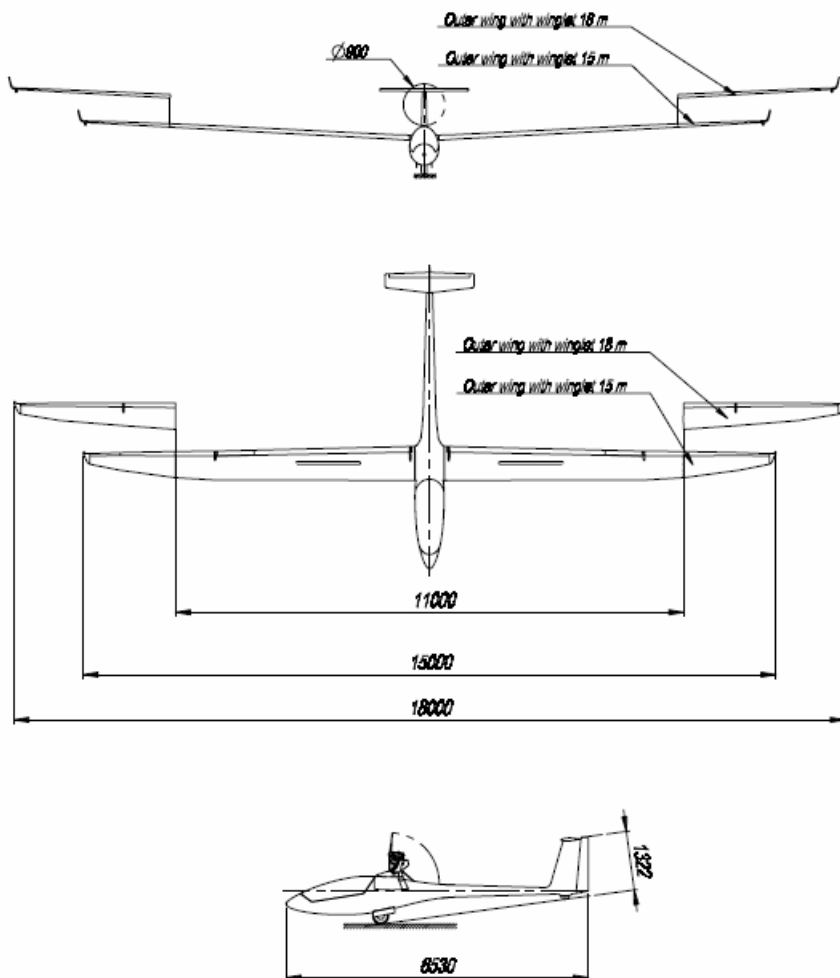

## 1.6 Abbreviations

CAS	- calibrated airspeed means indicated airspeed of a sailplane, corrected for position (due to position of pressure ports on sailplane) and instrument error. Calibrated airspeed is equal to true airspeed in standard atmosphere at sea level.
C.G.	- center of gravity.
daN	- decanewton.
h	- hour.
IAS	- indicated airspeed means the speed of a sailplane as shown on its pitot – static aircraft indicator and is uncorrected for the system error.
m	- meter.
kg	- kilogram.
km	- kilometer.
s	- second.
ltr	- liter.

## 1.7 Unit conversions

1 bar = 14,5 pounds per square inch (psi);
1 decanewton (daN) = 2,25 pounds force;
1 kilogram (kg) = 2,2 pounds (lbs);
1 meter (m) = 39,4 inches (in.) = 3,28 feet (ft.);
1 millimeter (mm) = 0,0394 inches (in.);
1 liter = 0,2642 U.S. gal;
1 square meter (m <sup>2</sup> ) = 10,764 sq.ft;
1 kg/m <sup>2</sup> = 0,204 lbs/sq.ft;
1 m/s = 1,944 knots (kts);
1 km/h = 0,5396 kts;
1 kW = 1,34 HP.

## Chapter 2 LIMITATIONS

2.1	Introduction.....	2-2
2.2	Airspeed.....	2-2
2.3	Airspeed indicator markings .....	2-4
2.4	Power-plant information and operation limitations.....	2-4
2.4.1	Power-plant.....	2-5
2.4.2	Fuel tank and fuel.....	2-5
2.5	Mass (weight) .....	2-5
2.6	Center of gravity .....	2-6
2.7	Approved manoeuvres .....	2-6
2.8	Manoeuvring load factors .....	2-6
2.9	Flight crew .....	2-6
2.10	Kinds of operation .....	2-7
2.11	Minimum equipment.....	2-7
2.12	Aero tow, winch and auto tow launching.....	2-8
2.13	Other limitations .....	2-8
2.14	Limitation placards .....	2-9

## 2.1 Introduction

Chapter 2 includes operation limitations, instrument markings and placards necessary for safe operation of the LAK-17BT self-sustaining powered sailplane, it's engine, standard systems and standard equipment.

The limitations has been approved. Compliance with these limitations is mandatory.

**Warning:** *LAK-17BT is a self-sustaining powered sailplane and is prohibited from taking off solely by the means of it's own power.*

**Note:** *due to high noise when engine is running, it is highly recommended to wear headset during powered flight*

## 2.2 Airspeed

Airspeed limitations and their operational significance are shown below:

Speed		IAS; km/h / (kts)	Remarks
		15 m & 18 m	
V <sub>NE</sub>	Never exceed speed	275 / (148) 260 / (140) 245 / (132) 220 / (119) 195 / (105)	Do not exceed this speed in any operation and do not use more than 1/3 of control deflection at:  0 - 4 000 m (0 - 13 100 ft) up to 5 000 m (16 400 ft) up to 6 000 m (19 680 ft) up to 8 000 m (26 250 ft) up to 10 000 m (32 800 ft.)
V <sub>PE</sub>	Maximum operation with power-plant extended	160 / (86)	Do not exceed this speed with the power-plant extended (at any power setting or propeller stopped)
V <sub>RA</sub>	Rough air speed	190 / (102)	Do not exceed this speed except in smooth air and then only with caution. Rough air is in lee wave rotor, thunderclouds, etc.



Speed		IAS; km/h / (kts)	Remarks
		15 m & 18 m	
V <sub>A</sub>	Manoeuvring speed	190 / (102)	Do not make full or abrupt control movement above this speed, because under certain conditions the sailplane may be over stressed by full control movement
V <sub>FE</sub>	Maximum flap extended speed. Flap setting: -1 up to 0 +1 up to L	275 / (148) 160 / (86)	Do not exceed these speeds with the given flap setting
V <sub>W</sub>	Maximum winch and autotow launch speed	140 / (76)	Do not exceed this speed during winch or autotow-launching
V <sub>T</sub>	Maximum aero towing speed	160 / (86)	Do not exceed this speed during aero towing
V <sub>LO</sub>	Maximum landing gear operations speed	205 / (110)	Do not extend or retract the landing gear above this speed
V <sub>POmin</sub>	Minimum speed to extend or retract the power-plant	90* / (49*)	Do not extend or retract the power-plant below this speed
V <sub>POmax</sub>	Maximum speed to extend or retract the power-plant	110 / (60)	Do not extend or retract the power-plant above this speed

**Warning:**

*At higher altitudes the true airspeed is higher than the indicated airspeed, and V<sub>NE</sub> is reduced with altitude.*

**\* Warning:**

*select your power-plant extension retraction speed correctly:*

- *flaps must be at +2 position;*
- *make sure your selected speed for power-plant extension / retraction is at least 8...10 km/h (4...5 kts) higher as if stall speed for your flight configuration.*

### 2.3 Airspeed indicator markings

Airspeed indicator markings and their color code significance are shown below:

Marking	IAS value or range km/h / (kts)	Significance
White Arc	102...160 / (55...86)	Positive Flaps Operating Range: Lower limit is 1,1 $V_{SO}$ in landing configuration at maximum weight. Upper limit is maximum speed permissible with flaps extended positive.
Green Arc	108...190 / (58...102)	Normal Operating Range: Lower limit is 1,1 $V_{S1}$ at maximum weight and most forward C.G. with flaps neutral. Upper limit rough air speed.
Yellow Arc	190...275 / (102...148)	Manoeuvres must be conducted with caution and only in smooth air.
Red Line	275 / (148)	Maximum speed for all operations.
Blue line	95 / (51)	Speed for best climb $V_v$ , flaps in position "+2"
Yellow Triangle	95 / (51)	Approach speed at maximum weight without water ballast

### 2.4 Power-plant information and operation limitations

LAK-17BT is equipped with self-sustaining power-plant and is prohibited from taking-off solely. Therefore use of the power-plant has some limitations which needs to be observed:

- extend and retract engine only at the speed range  $V_{PO} = 90 \dots 110$  km/h (49...60 kts);
- do not fly glider with engine extended at the speed higher as  $V_{PE} = 160$  km/h (86 kts);
- during extension/retraction of the power-plant avoid excessive g-loads.

The power-plant has the following unusual features:

- no engine starter (start up by wind milling propeller);
- engine cylinders decompression is used to ease to wind mill propeller;
- no throttle - operation only with full RPM (RPM can be changed only by changing speed of the glider);
- propeller brake is used to stop and locate propeller in needed position.

### 2.4.1 Power-plant

#### Engine:

Engine manufacture: Solo Kleinmotoren GmbH  
 Postfach 60 01 52, D 71050 Sindelfingen, Germany;  
 Engine model: SOLO 2350;  
 two cylinder, air cooled, two stroke engine;  
 Maximum power: max power 19,6 kW (26,28 hp) at 5500 RPM;  
 Continuous power: engine is continuously operated at the max power;  
 Max. engine RPM: 6500 RPM;  
 Recommended RPM: 5000 RPM;  
 Fuel consumption: 12 ltr/h (3,17 U.S. gal/h);  
 Maximum CHT: 275 °C (527 °F) measured at a spark plug.

#### Propeller:

Propeller: diameter 0,9 m (2,95 ft.);  
 Manufacture: Joint Stock Company "SPORTINÉ AVIACIJA"  
 Model: LAK-P4-90;

### 2.4.2 Fuel tank and fuel

LAK-17BT has a fuselage fuel tank only.

Fuel tank capacity: 7,5 ltr (2 US gal);  
 Non useable amount of fuel: 0,3 ltr (0,1 US gal);  
 Useable amount of fuel: 7,2 ltr (1,9 US gal).

Approved fuel grades: two stroke mix (gas/oil) – min 95 RON, AVGAS 100LL  
 mixed at ratio 30:1 with two stroke oil Castrol Super TT.

### 2.5 Mass (weight)

Maximum take-off mass of the LAK-17BT is:  
 with water ballast-

for 15m..... 550 kg (1212,5 lbs);  
 for 18m..... 600 kg (1322,8 lbs).

Maximum landing mass:

for 15m..... 550 kg (1212,5 lbs);  
 for 18m..... 600 kg (1322,8 lbs).

#### **Note:**

*When landing on a rough and hard surface always dump all water ballast before to land.*

Maximum mass of all non lifting parts	290,2 kg (639,8 lbs);
Maximum mass in baggage area	7 kg (15,4 lbs).

**Caution:**      *Heavy pieces of baggage must be secured to the baggage compartment floor.*

## 2.6 Center of gravity

Position of C.G. in flight:

- front limit ( <b><i>critical for the engine extracted</i></b> ):	206 mm aft of wing root rib leading edge;
- rear limit ( <b><i>critical for the engine retracted</i></b> ):	328 mm aft of wing root rib leading edge.

**Warning:**      *The sailplane may be safely operated only when loaded in the range defined in the Chapter 6 of this manual.*

## 2.7 Approved manoeuvres

This sailplane is certified for normal gliding in the "Utility" category according to CS-22. Aerobatic manoeuvres are not permitted.

## 2.8 Manoeuvring load factors

Limit load factors are:

- for $V_A = 190$ km/h (102 kts) airspeed	+5,3 / -2,65;
- for $V_{NE} = 275$ km/h (148 kts) airspeed	+4,0 / -1,5;
- for $V_{NE} = 275$ km/h (148 kts), air brakes extended	+3,5 / 0;
- for $V_F = 160$ km/h (86 kts), flap +1, +2, L	+4 / 0;

## 2.9 Flight crew

LAK-17BT is a single seat motor-glider. Load in a pilot seat must be as follows:

Max load in the seat	110 kg (242 lbs.);
Min load in the seat	see placard in cockpit and weighing report.

With these loads, the C.G. range given in 2.7 will be in the limits if the empty glider weight and C.G. is in the limits (see empty center of gravity chart in Chapter 6).

**Caution:**            *With low pilot weight lead ballast must be added to the nose of the cockpit.*

## 2.10    **Kinds of operation**

Flights must be conducted under Day / VFR conditions.

Where permitted by national regulations, cloud flying may be conducted but only with 15m wings (including 15m winglets) and without water ballast. Consider the different national legal requirements (for e.g. additional equipment) for cloud flying (see also point 2.11).

Aerobatic maneuvers are not permitted.

**Warning:**            *LAK-17BT is a self-sustaining powered sailplane and is prohibited from taking off solely by the means of it's own power.*

**Warning:**            *Flying with removed engine is not allowed.*

## 2.11    **Minimum equipment**

As minimum equipment only the instruments and equipment specified herein and in the equipment list (see Maintenance Manual Section 2) are admissible:

- airspeed indicator, scale 50...300 km/h (27...162 kts), with range markings (see Chapter 2.3);
- altimeter with altitude corrector and fine range pointer;
- magnetic direction indicator (compensated in an aircraft);
- four point symmetrical seat harness;
- power supply;
- ILEC MCU for LAK-17BT engine instrument, which incorporates:
  - engine speed indicator;
  - fuel quantity indicator;
  - battery level;

- cylinder head temperature indicator;
- engine elapsed time indicator (counts engine hours);
- rear view mirror;
- outside air temperature (OAT) gauge (if water ballast is carried);
- emergency locator transmitter (ELT) (if required by national regulations);
- required placards, check lists and flight manual.

For cloud flying the following additional equipment is required:

- variometer;
- turn and bank indicator, non-icing.
- transceiver ready for operation;
- parachute, automatic or manual opening type;
- non-icing airspeed system.

The minimum equipment must correspond with national regulations.

## 2.12 Aero tow, winch and auto tow launching

The maximum launch speeds for both 15 m and 18 m wing are:

Aerotow.....	160 km/h (86 kts);
Winch / auto-tow launch.....	140 km/h (76 kts).

For all of the above launching methods a weak link of 780 daN (1753 lbs) must be used in the launch cable or towrope.

For aerotow, the towrope must be at least 20m (66 ft.) long.

**Warning:** *For winch or auto-tow launch, only the C.G. hook can be used.*

**Warning:** *Aerotow launches are only allowed at the aerotow hook.*

## 2.13 Other limitations

### Crosswinds

The maximum demonstrated crosswind component according to the airworthiness requirements for take-off and landing is 15 km/h (8 kts).

## Water Ballast

Filling of the wing water ballast tanks must result in the symmetrical loading condition only. After filling, balance the wings by dumping enough water from the heavy wing to achieve lateral balance. Flight with leaking water ballast is not permitted as this may result in asymmetrical loading. For maximum permissible water ballast see paragraph 6.9.

**Warning:** *Flight with water ballast must be conducted at an OAT greater than +2 °C (36 °F). Otherwise jettison both wing and fin water ballast in order to prevent structural damages due to freezing of water.*

**Warning:** *Maximum take-off weight must not be exceeded.*

## 2.14 Limitation placards

The following limitation placards are installed in a glider:

Air speed data and loading placard in a cockpit:

LAK-17BT 15/18m - AIR SPEED DATA & LOADING PLACARD						
Speed IAS:		km/h	kts	Masses and loads	kg	lbs
Never exceed	V <sub>NE</sub>	275	148	Max. mass with water ballast	550/600	1212.5/1322.8
Rough air	V <sub>RA</sub>	190	102	Maximum cockpit load	110	242
Manoeuvring	V <sub>A</sub>	190	102	Minimum cockpit load		
Aerotow	V <sub>T</sub>	160	86			
Winch-launch	V <sub>W</sub>	140	76	Recommended weak link	780 daN	1753 lbs
Landing gear oper.	V <sub>L</sub>	205	110			
Power-plant oper.	V <sub>PE</sub>	160	86			
Max. engine ext/ret	V <sub>POmax</sub>	110	60	<b>Aerobatic manoeuvres are not permitted</b>		
Min. engine ext/ret	V <sub>POmin</sub>	90	49			

RPM indication (LED) meanings - located as close as possible to MCU:

RPM indications	
Green	4500...5800
Yellow	5800...6500
Red	> 6500

Fuel type and fuel tank information - near the fuel tank filling connection:

<b>Fuel - two stroke mixture:</b> Min. 95 RON; AVGAS 100LL / two stroke oil Castrol Super TT <b>30:1</b>
Fuel tank capacity = 7,5 ltr. (2 US gal.) Usable amount of fuel = 7,2 ltr. (1,9 US gal.)

m - <b>Altitude</b> - ft		km/h - <b>V<sub>NE</sub></b> , <b>IAS</b> - kts	
4000	13100	275	148
5000	16400	260	140
6000	19680	245	132
8000	26250	220	119
10000	32800	195	105

High altitude flights  $V_{NE}$  limitations - on a right-side canopy rail, for the pilot in flight visible place.

Nose ballast limitations placard - located at a bulkhead at the nose of the glider (optional).

Nose ballast	
Max permitted 5,25 kg (11,6 lbs.)	
<b>Reduction of the min. cockpit load by:</b>	<b>Lead weight required</b>
5 kg (11 lbs)	1,75 kg (3,9 lbs)
10 kg (22 lbs)	3,5 kg (7,7 lbs)
15 kg (33 lbs)	5,25 kg (11,6 lbs)

Max baggage weight 7 kg (15,4 lbs)
---------------------------------------

In a baggage area

Pressure in a main wheel tire from 2,3 to 2,5 bar
--

On a main gear door

Pressure in a tail wheel tire from 1,8 to 2,0 bar
--

Next to the tail wheel



### Chapter 3

## EMERGENCY PROCEDURES

3.1	Introduction.....	3-2
3.2	Canopy jettison .....	3-2
3.3	Bailing out .....	3-2
3.4	Stall recovery .....	3-3
3.5	Spin recovery .....	3-3
3.6	Spiral dive recovery .....	3-3
3.7	Engine failure.....	3-3
3.8	Fire.....	3-4
3.8.1	Engine fire during flight.....	3-4
3.8.2	Fire in the fuselage.....	3-4
3.9	Loss of electrical power in flight .....	3-5
3.10	Landing with the engine extended and stopped .....	3-5
3.11	Recovery from unintentional cloud flying.....	3-5
3.12	Flight with asymmetrical water ballast.....	3-6
3.13	Emergency wheel up landing .....	3-6
3.14	Ground loop.....	3-6
3.15	Ditching landing on water .....	3-6

### 3.1 Introduction

Chapter 3 provides a checklist and explanations for coping with emergencies that may occur. Emergency situations can be minimized by proper pre-flight inspections and maintenance.

### 3.2 Canopy jettison

The following steps accomplish canopy jettison:

1. Pull the red canopy jettison handle aft to the limit of its travel.
2. Release the handle.

The canopy jettison handle is located on the instrument panel and has an icon describing its function. A compression spring in the canopy hinge pushes the canopy upward and lets the airflow to lift the front of the canopy upward while the rear of the frame pivots about a small lip on the fuselage. This system is designed to lift the canopy up and away from the flying glider to allow the pilot a quick bailout from the cockpit.

If necessary, you have to push the canopy upwards with both hands on the Plexiglas.

**Warning:** *The red handle of the spring-type mechanism on the canopy hinge must be in the unlocked (working) position.*

### 3.3 Bailing out

First jettison the canopy then unlock the safety harness and bail out. The low walls of the cockpit allow for a quick push-out exit.

It is recommended that bail out procedures be practiced on the ground at the beginning of each flying season.

**Warning:** *If you have to bail out with the engine running, retract the engine, if there is time enough to do so, as follows: switch off the ignition, close fuel cock, apply propeller brake (even if propeller is in wrong position or not stopped - engine will not retract until propeller brake is off!) and retract the engine by switching MCU switch to “retract” position.*

**Warning:** *If there is no time to stop the propeller and retract the engine try to avoid the engine and propeller by leaving the sailplane beneath the wing.*

### 3.4 Stall recovery

Stall recovery is accomplished by easing the stick forward and if necessary picking up a dropping wing with sufficient opposite rudder.

### 3.5 Spin recovery

Apply full opposite rudder against the direction of rotation and ease the stick forward until the rotation stops. At aft C.G. positions the glider may move temporarily to a nose up position making it necessary to apply full stick forward. As the rotation stops centralize the controls and carefully pull out of the dive. The ailerons should be kept neutral during spin recovery.

Recovery from unintentional spins should be done immediately.

**Caution:** *Altitude loss due an incipient spin from straight flight with prompt recovery is 30 m (98 ft.), increasing to 60 m (196 ft.) from circling flight and 60 m (196 ft.) to 120 m (394 ft.) with airbrakes extended. Maximum speed during recovery is 190 km/h (103 kts).*

### 3.6 Spiral dive recovery

To recover from a spiral dive, apply rudder and aileron in the direction opposite to the spiral dive rotation and carefully pull out of the dive

### 3.7 Engine failure

In a case of engine failure, stop the engine and retract. If electric system failed and engine cannot be retracted, immediately look for the landing sight and land.

**Warning:** *Stall speed will increase, fly faster. Glide ratio with the engine extended and stopped is degraded down to about 18 units and sink rate is about 1,8 m/s (355 ft./min).*

### **3.7.1 Power loss during flight**

If power is lost during flight push the control stick forward immediately, watch the airspeed indicator!

Check:

- fuel cock position?
- fuel quantity?

If no change, retract engine or land with engine extended.

## **3.8 Fire**

### **3.8.1 Engine fire during flight**

If engine fire occurs during start of engine or in flight:

- close fuel cock, switch off the ignition and the main switch;
- keep the engine extended;
- land as soon as possible;
- extinguish fire.

### **3.8.2 Fire in the fuselage**

Fire in the front part of the fuselage (electrical fire):

- main switch off;
- close ventilation and open canopy side window;
- land as soon as possible if the fire is not extinguished (circuits are protected by the circuit breakers).

Fire in the rear section of the fuselage (engine retracted):

- close fuel cock;
- if smoke prevents flying open ventilation;
- land as soon as possible;
- extinguish fire.

### 3.9 Loss of electrical power in flight

With the engine retracted:

- continue flying as a sailplane.

With the engine extended not running:

- even if electric power failed, in a case when engine is extracted, it is possible to start the engine. Visually make sure engine is completely extended and propeller brake is off. Switch ignition "on" and start normal starting procedure. Otherwise look for a landing field to do a safe out-landing. As far as all engine extension systems are electrically powered, in a case of electrical power failure, engine cannot be retraced or extended. It is recommended to approach somewhat faster than usual.

**Warning:** *Stall speed will increase, fly faster. Glide ratio with the engine extended and stopped is degraded down to about 18 units and sink rate is about 1,8 m/s (355 ft./min).*

With the engine extended and running:

Don't stop the engine. Fly to the next airfield and land. Landing with the engine extended see sect. 3.10.

While engine is running, engine can be operated with no electric power because all engine systems are driven by the engine itself and do not require external electrical power source. In this case MCU will not function and monitoring of the engine performance will be impossible. But flying at the speed about 90...100 km/h (49...54 kts) and monitoring engine visually powered flight can be successfully continued to the nearest airfield as long as there is some fuel in a tank.

### 3.10 Landing with the engine extended and stopped

Wing flap setting "L". Landing with the engine extended and stopped is not a potential risk. However due to the high drag from the extended engine, the approach should be made using airbrakes not fully extended. This procedure is only allowed in a case of an emergency and with ignition switched off.

Fully extended airbrakes may result in a heavy and uncomfortable landing. It is recommended to approach somewhat faster than usual. Engine extended reduces L/D to about 18!

### 3.11 Recovery from unintentional cloud flying

At speeds below 190 km/h (102 kts), extend the dive brakes fully. At higher speeds, up to  $V_{NE}$ , pull out the dive brakes very carefully and expect high aerodynamic

forces and g-loads. Enter the descent and fly normally until leaving the cloud. When clear of the cloud, retract the dive brakes and reduce speed. Spins are not to be used to lose altitude.

### **3.12 Flight with asymmetrical water ballast**

If you suspect that the water ballast is not dumping symmetrically you should close the dump valves immediately to avoid greater asymmetry. Asymmetry can be verified by the necessary aileron deflection in straight flight at low airspeeds.

When flying with asymmetric water ballast you must increase your airspeed, especially in turns, so that you can avoid stall at all costs. Should the aircraft enter a spin under these conditions, aggressive stick forward spin recovery will be necessary. Fly the landing pattern and touch down with approximately 10 km/h (5,4 kts) faster than normal and after touch down attempt to control the bank angle to avoid the heavy wing from touching the ground too early.

### **3.13 Emergency wheel up landing**

An emergency wheel up landing is not recommended since the absorption capability of the fuselage is much smaller than that of the landing gear. If the landing gear cannot be extended the landing touchdown should be at slow speed.

### **3.14 Ground loop**

If there is a risk of overshooting the landing area after touchdown an intentional ground loop may be initiated by forcing a wing tip to the ground and at the same time you should PUSH the stick forward to lighten the load on the tail wheel and apply the opposite rudder.

### **3.15 Ditching landing on water**

Our experience shows that in ditching the cockpit area likely will be forced downward under water. Therefore an emergency landing on water is recommended only with the landing gear extended and then only as a last resort.

---

## Chapter 4 NORMAL PROCEDURES

4.1	Introduction.....	4-2
4.2	Rigging and de-rigging, filling the water tanks, refueling.....	4-2
4.2.1	Rigging and de-rigging .....	4-2
4.2.2	Filling the water tanks.....	4-3
4.2.3	Refueling.....	4-4
4.3	Daily Inspections .....	4-4
4.4	Pre-flight inspection.....	4-6
4.5	Normal procedures and recommended speeds .....	4-7
4.5.1	Aero tow launch.....	4-7
4.5.2	Winch- launch or auto tow.....	4-8
4.5.3	Free flight.....	4-8
4.5.4	Low speed flight and stalling behavior .....	4-9
4.5.5	Cruise with running engine .....	4-9
4.5.6	Approach and landing .....	4-9
4.5.7	Extension and starting/restarting the engine in flight .....	4-10
4.5.8	Stopping and retracting the engine in flight .....	4-11
4.5.9	Flight with water ballast.....	4-11
4.5.10	High altitude flights .....	4-12
4.5.11	Flight in Rain .....	4-12
4.5.12	Engine starting on the ground .....	4-12
4.5.13	Engine retraction on a ground.....	4-13

## 4.1 Introduction

This chapter provides checklists and explanations of procedures for conducting normal operating procedures. Normal procedures associated with optional equipment can be found in Chapter 9.

## 4.2 Rigging and de-rigging, filling the water tanks, refueling

### 4.2.1 Rigging and de-rigging

The following procedures are recommended for rigging and de-rigging the LAK-17BT sailplane:

1. Clean and lubricate all pins, bushings and control connections. Inspect the pins and bushings for burrs and gouges.
2. Support the fuselage and keep it upright, open the canopy and lower the landing gear. Place the control stick in the center of its travel. Position the dive brake handle near its most forward position, flaps handle in “-1” position. Put the water ballast control in the forward, closed position.
3. Be sure the dive brake system in the wings is not locked. Remove any supports or locks over the ailerons.
4. Insert the left wing spar fork into the fuselage. As the wing root approaches the fuselage look to be sure the automatic hook ups for the aileron, flaps and dive brake properly engage. Look to see if the water ballast control is engaging correctly. After the wing is pushed into position support the wing tip.

**Note:** *It's not allowed to rig or de-rig wings with 15m or 18m outer wings with or without winglets installed.*

5. Insert the right wing spar into the fuselage. As the wing root approaches the fuselage look to be sure the automatic hook ups for the aileron, flap and dive brake properly engage. Look to see if the water ballast control is engaging correctly. Line up the main pin bushings. Insert both spar pins fully. Lock the main wing pin handles.

**Warning:** *Lock the main wing pin handles with fixing studs.*



6. Install outer wing 15m or outer wing 18m, lock and secure. To connect left and right winglets: screw bolt M5 into the wingtip/winglet fixator and pull it out until it reaches the stop. While holding fixator in lifted position, push the winglet completely into the wing. Release fixator, push it down flush with the wing surface, remove the bolt. Pull on the winglet to make sure it is locked.
7. Install the batteries into the batteries box.

**Warning:**        *for the glider with power-plant installed, fin battery has to be removed. Only the baggage compartment batteries can be installed.*

8. Slide the stabilizer onto the drive pins and look to make sure the automatic hook-ups for the elevator properly engage. Push the stabilizer all the way onto the drive pins. Screw the locking bolt in and make sure, that the bolt is fixed. After removing the assembly tool, place a piece of glider tape over the locking bolt.

**Warning:**        *for de-rigging, before unscrew mounting bolt, unfix it by pulling out locking pin.*

9. Apply sealing tape to the wing/fuselage gaps.
10. Perform a positive control check for all controls.
11. Install total energy tube and temporary equipment (barographs etc.)
12. Perform Daily Inspection.
13. De-rigging follows the reverse order of rigging. Confirm that water ballast has been dumped before de-rigging. Also see Maintenance Manual Section 3.

**Note:**            *Remove the stabilizer before removing the wings.*

#### **4.2.2    Filling the water tanks**

If water ballast is necessary, fill each wing tank according to the loading chart (see Chapter 6) and confirm symmetrical loading by balancing at the wing tip. The inner wing ballast is filled through the dumping valves at the bottom side of the wing using special filling equipment. A light coating of waterproof grease applied to the dump valve seat will help insure the valve is leak free. The outer wing ballast is filled through the filling opening at the end wing rib.

Fin water ballast is filled through the filling opening at the top of the fin. This can be done with or without stabilizer installed. Fill fin tank according to the loading chart (see Chapter 6).

**Warning:** *allow tanks to vent while filling. Do not fill with pressure exceeding 1 psi / 0,06 bar as the structure could be damaged. Check for proper dump valves operation prior to flight. Do not exceed the maximum gross weights.*

### 4.2.3 Refueling

Preferably fuel is transferred from a can where the correct amount of oil is added and mixed prior to filling. Refueling is done via the tank filler connection located inside of the power-plant bay. To get access to the fuel tank filling connection, switch MCU “extract/retract” switch to the extract or retract position and when door opens, and prior it closes, switch the switch to the neutral position. This will stop extraction/retraction procedure and give you access to fill fuel tank.

Only approved oils can be mixed in to the fuel (see chapter 2.4.2).

**Warning:** *When refueling, be careful do not spill fuel in to the fuselage and not overfill the fuel tank.*

**Warning:** *During refueling ground the fuel tank.*

**Calibration of the fuel type** - refer to the Chapter 7.18 “Calibration of fuel type”.

### 4.3 Daily Inspections

Please keep in mind the importance of the inspection after rigging the glider and respectively each day prior to the first take off. As a minimum check the following items. If any problems are found they must be corrected before flying.

1. Airworthiness documents, placards and markings.
2. Check fore part of fuselage.
3. Check a pilot cockpit:
  - cockpit area for lose objects or damaged components;
  - the pilot cockpit canopy glass;
  - operation of pilot cockpit canopy lock, canopy jettison system;
  - unlock canopy jettison system if locked;
  - wings connection pins locked;
  - operation of towing hook(s);
  - operation of water ballast system;

- operation of control systems: ailerons, flaps, elevator, rudder and airbrakes (confirm that air brakes lock when closed);
- operation of pilot cockpit ventilation, seat back adjustment;
- operation of a trimmer;
- batteries and oxygen bottle for condition, properly secured;
- operation of flight instruments (especially pneumatic);
- radio communication;
- safety belts.

**Warning:**        *for the glider with power-plant installed, fin battery has to be removed. Only the baggage compartment batteries can be installed.*

4. Check main and tail wheel tires pressure and operation of the main wheel brake.
5. Check the left wing:
  - upper and lower wing surfaces;
  - leading edge;
  - upper and lower surfaces of ailerons and flaps;
  - deflections of ailerons and flaps and their clearances;
  - airbrakes for proper function and locking;
  - ailerons and flaps attachment to the wing;
  - clearance between the wing and the fuselage;
  - winglets installed, locked and secured.
6. Check function of control systems (of an ailerons, flaps, airbrakes), their connections to corresponding control systems in the fuselage.
7. Check the fuselage exterior surface.
8. Check a stabilizer, an elevator and a rudder:
  - surfaces;
  - deflections and clearances of controls;
  - fixing of joint of the stabilizer attachment to the fin;
  - clearance of the stabilizer with respect to the fin.
9. Check the right wing (same as for the left wing according to point 5).
10. Check the power-plant:
  - cockpit power-plant controls for operation;
  - extension-retraction system by operating it in both directions.
  - extend the engine:
    - (a) all screwed connections and their securing;
    - (b) functioning of de-compressor and propeller brake;
    - (c) ignition system including wires and the spark plug connectors for tight fit;
    - (d) engine retaining cable and its connections in the engine compartment and to the engine;
    - (e) fuel lines, electrical wires, bowden cables and structural parts for wear and kinks;

- 
- (f) exhaust muffler, propeller flange and accessories for tight fit and any cracking;
  - (g) apply moderate pressure to the propeller in forward, backward and sideward direction to check if there is any looseness;
  - (h) visually check the propeller;
  - (i) turn the propeller one revolution by hand listen for abnormal sounds which may indicate engine damage;
  - (j) check the fuel level. It is suggested to fill fuel tank completely before every flight; drain condensed water from the fuel tank. The drainer is located in the main wheel box (to drain the fuel tank, lower the left wing);
  - (k) Check the outlet of the fuel tank vent line for cleanliness, the outlet is located directly behind the landing gear box;
  - (l) Check the fuel filter for dirt or sludge - the filter is located on a right side of the power plant bay.

**Caution:** *After a hard landing or if high loads have been experienced, a complete inspection according to the Maintenance Manual Section 5.5 must be performed. Contact the manufacture for assistance if required.*

#### **4.4 Pre-flight inspection**

1. Main spar pins installed and locked.
2. Controls checked for operation and freedom of movement.
3. Lead or water ballast for underweight pilot installed or filled.
4. Tail dolly removed.
5. Unlock canopy jettison system if locked;
6. Batteries and oxygen bottle installed, properly secured;
7. Pilot safety harness connected and properly adjusted / tightened.
8. Seat back and rudder pedals adjusted.
9. All control knobs within reach.
10. Water ballast checked, dump valve closed and vents open.
11. Airbrakes closed and locked.
12. Trim set to take-off position.
13. Flaps set to take-off position.
14. Check wheel brake.

15. Altimeter set correctly
16. Check direction of wind component.
17. Close and lock canopy.
18. Max. mass not exceeded.

**If powered flight is planned or expected:**

19. Fuel level checked.
20. Engine installation checked.

**Note:** *if power-plant was not in use for up to two months and conservation for storage is not planned as per engine manual, prior performing next flight power-plant inspection as per Maintenance Manual of a glider, paragraph 5., items "Power-plant installation" has do be done including performing ground test run of the engine.*

#### **4.5 Normal procedures and recommended speeds**

Normal flight operation procedures and the corresponding recommended air speeds are as follows.

##### **4.5.1 Aero tow launch**

Flaps should be set at take off position "+1" when C.G. is at rearmost position and "+2" at middle and foremost position of C.G. Trim should be set forward of neutral.

**Warning:** *aerotow launches are only allowed at the aerotow hook.*

**Warning:** *when water tanks are partially filled, keep wings horizontal before take off to avoid uneven water distribution.*

**Warning:** *it is not allowed to take off with the engine extended.*

Weak link in tow cable max 780 daN (1753 lbs). Use wheel brake during tightening of tow cable to avoid rolling over tow cable.

**Minimum aero tow speed:**

- without water ballast.....100 km/h (54 kts).
- with water ballast.....120 km/h (65 kts).

### 4.5.2 Winch- launch or auto tow

Trim should be set forward of neutral. Set flaps to "+1" at rearmost position of C.G. and "+2" at middle and foremost position of C.G.

**Warning:** *for winch or auto-tow launch, only the C.G. hook can be used.*

**Warning:** *it is prohibited to use the aerotow hook for winch or auto-tow launches.*

**Warning:** *it is not allowed to take off with the engine extended.*

**Warning:** *when water tanks are partially filled, keep wings horizontal before take off to avoid uneven water distribution.*

Weak link in tow cable max 780 daN (1753 lbs). Use wheel brake during tightening of tow cable to avoid rolling over tow cable. Pronounced forward stick pressure is required during transition arc.

**Minimum winch launch / auto tow speed:**

without water ballast.....100 km/h (54 kts).

with water ballast.....120 km/h (65 kts).

### 4.5.3 Free flight

Circling flight (thermalling) with flaps position "+2", stick forces to zero. Best gliding ratio is between 95 and 105 km/h (51 and 57 kts.).

For high speed flight up to 275 km/h (148 kts.) position flaps between "0" and "-1" according to speed.

Due to flap control forces, flaps position "+2" may not be set above 160 km/h (86 kts.).

Recommended flaps positions:

Flap position	Speed, km/h / (kts.)	
	without water ballast	with maximum take off weight
L	landing	landing
+2	≤90 / (49)	≤110 / (60)
+1	90...120 / (49...65)	110...150 / (60...81)
0	110...180 / (60...97)	140...220 / (76...119)
-1	150...275 / (81...148)	190...275 / (103...148)

#### 4.5.4 Low speed flight and stalling behavior

The LAK-17BT behaves normally in slow and stalled flight.

With a forward C.G. position there is no stall warning, but the stall characteristics are very gentle and large aileron deflections can be applied without dropping the wing.

At rearward C.G. positions airflow separation over the fuselage results in buffeting and gives warning to an impending stall. Full and sudden aileron or rudder deflections will result in a spiral dive, spin entry or slide slip depending on the C.G. position.

**Caution:** *Altitude loss due to an incipient spin from straight flight with prompt recovery is approximately 30 m (100 ft.), increasing for circling flight.*

**Caution:** *Stall warning with extended engine is marginal and covered by the engine vibration. Increase the approach speed.*

#### 4.5.5 Cruise with running engine

##### **General:**

The engine of the LAK-17BT can be used for long continuous cruise at maximum continuous power. The system has no throttle so the climb speed can only be manipulated via the cruise speed (for example if there is a ATC request for a level flight). Or manipulating the RPM via the climb speed. Due to the high drag of the extended power plant and as the propeller is designed for optimum climb performance, cruise with higher speed is not efficient.

The maximum range of the powered flight is 150 km (93 miles).

#### 4.5.6 Approach and landing

Land always in the gliding configuration, engine retracted!

Recommended flaps position is “L” (landing).

In light winds and without water ballast the approach to landing should be flown at about 95 km/h (51 kts.). Stronger winds require increased airspeeds. The very effective dive brakes make a short landing possible; however, do not approach too slowly with fully extended dive brakes as the aircraft may drop during the flare out. The glider should touch down on the main and tail wheel. The main wheel brake can then be applied for a shortened ground roll. When flying with inside - slip with

airbrakes extended vibrations of the sailplane occurs. The control stick should be in aft position. Due to side - slip control force decrease or reversal is possible.

**Warning:** *Stall speed will increase, fly faster. Glide ratio with the engine extended and stopped is degraded down to about 18 units and sink rate is about 1,8 m/s (355 ft./min).*

**Caution:** *Stall warning with extended engine is marginal and covered by the engine vibration. Increase the approach speed.*

Landing with the engine extended and stopped - see emergency procedures chapter 3.10. Land with the engine extended only if the engine can't be retracted.

#### **4.5.7 Extension and starting/restarting the engine in flight**

(a) With the engine extracted, but not running the rate of sink at 90 km/h (49 kts) increases to 1,8 m/sec (355 ft./min). Therefore starting/restarting the engine should only be done over landable terrain and not below 400 m (1315 ft.) above ground. Should a flight be conducted over a wide expanse of un-landable terrain, the engine should then be started/restarted at 1000 m (3300 ft) above ground level so that if the engine does not start, all the emergency starting procedures must be followed in place including retraction of the engine if necessary.

(b) In a normal starting situation the loss of altitude from starting the extension procedure until the engine is running is about 70 m (230 ft.) and the same for every restart. Time for extraction of the engine in flight is up to 15 sec.

(c) Extracting and starting the engine:

- Fly at 90\*...110 km/h (49\*...60 kts) with flaps set at +2. Avionics master switch must be "on".
- Engine electronics switch "on".
- Make sure propeller brake is on and fuel valve is closed.
- Extract the engine: to extract the engine the switch on the right side of the MCU display has to be switched up to the "extract" position. First the door opens till the limit switch for opened door activates. After this the engine extracts till the limit switch for engine is activated and then the door closes back.
- Open the fuel valve.
- Check if the control light "engine extended" is on.
- Check visually if engine is extracted.
- Remove propeller brake.
- Switch the ignition "on" (the switch is located under the LCD of MCU).
- Press fuel pump for few seconds.
- Open the de-compressor valve.
- Increase the speed to about 130...140 km/h (70 ... 76 kts).



- Release de-compressor. Engine should start.

**Warning:**        *always pay attention to the altitude!*

- \* Warning:**        *select your power-plant extension retraction speed correctly:*
- *flaps must be at +2 position;*
  - *make sure your selected speed for power-plant extension / retraction is at least 8...10 km/h (4...5 kts) higher as if stall speed for your flight configuration.*

#### 4.5.8 Stopping and retracting the engine in flight

- (a) Lift the rear view mirror so that you see the propeller.
- (b) Slow down to 90 ... 110 km/h (49 ... 60 kts).
- (c) Switch off the ignition.
- (d) Close the fuel valve.
- (e) To stop engine, open the de-compressor and release. Repeat if needed.
- (f) When propeller stops, apply propeller brake.
- (g) Check if propeller is in right position. If not, slightly open the de-compressor valves so propeller rotates and bottom on a propeller brake.
- (h) When propeller is stopped switch the extract/retract switch to the retract position.
- (i) After engine retraction set the ILEC-mcu switch to "off". With only short gliding flights i.e. saw tooth cross country flights, the switch can be left in position "on".

#### 4.5.9 Flight with water ballast

Flight in excess of the maximum gross weight 550 kg (1212,5 lbs) for 15m wing and 600 kg (1322,8 lbs) for 18m wing is prohibited. The maximum amount of water allowed depends on the empty weight of the sailplane combined with the total cockpit load (see Chapter 6.9).

**Warning:**        *Flight with water ballast must be conducted at an OAT greater than +2 °C (36 °F). If there is a risk of freezing temperatures, all water ballast, including fin water ballast must be dumped before freezing temperatures are reached. The flight conditions must comply with the following table:*

Ground Temperature	C°	10	15	20	30	40
	F°	50	59	68	86	104
Max. flight altitude	m	1200	2000	2700	4300	5800
	ft.	4000	6500	9000	14000	19000

**Filling and dumping the water ballast:**

After filling the ballast tanks either full or with partial loads the wings should be leveled and checked for symmetrical loading. Flight with leaking ballast valves is prohibited. Open ballast valves fully to dump water ballast.

A time to drain water ballast tanks:

- wing tanks ~ 4 min 30 sec;
- tail tank ~ 1 min 30 sec.

**Warning:**      *A filling ballast tank with pressurized water is prohibited. Always allow space for the displaced air to escape.*

**4.5.10 High altitude flights**

Indicated airspeed readings are progressively under-stated of true airspeed with higher altitudes. The limitations apply to high altitude flights as indicated at the placard given in a Chapter 2.14 of this manual.

Special care should be taken to ensure that there is no moisture on any section of the control junctions that could lead to freezing at high altitudes.

**4.5.11 Flight in Rain**

With light rain the stall speed and sink rate increase slightly, therefore landing approach speeds in rain must be increased. Rainwater on wings should be removed before take-off. Do not fly into icing conditions with a wet sailplane.

**With the engine running:**

In normal rain, the rate of climb will be reduced by 1/3. The cross-country cruising speed will also be reduced by approximately 10 km/h (5 kts).

**4.5.12 Engine starting on the ground**

- a) Sailplane master switch on.
- b) Switch ILEC-MCU switch on. Monitor the MCU for power up process to make sure instrument is functioning properly.
- c) Make sure propeller brake is on and ignition is off.
- d) Extract the engine: to extract the engine the switch on the right side of the MCU display has to be switched up to the “extract” position. First the door

- opens till the limit switch for opened door activates. Than the engine extracts till the limit switch for engine extracted is activated and then the door closes back.
- e) Check if the control light “engine extended” is on.
  - f) Remove propeller brake (right side of the cockpit).
  - g) Turn the propeller minimum one rotation by hand (make sure ignition is switched off and fuel is cut off).
  - h) Open the fuel cock (right side of the cockpit).
  - i) Switch on the ignition (the switch is located under the LCD of MCU).
  - j) Press the aft engine cylinder injection valve diaphragm and at the same time press the “Fuel pump” button for few seconds to fill fuel lines and inject some fuel into the cylinders;
  - k) Check the propeller is clear. Helping persons must secure glider at the fuselage nose and wing tip;
  - l) Pull the hand starter rope;

**Note:** *if engine does not start, it is possible that cylinders are flooded with the fuel. Switch the ignition off, open the de-compressor valves and turn propeller few revolutions by hand. Excess of the fuel will be pushed out through the de-compressor valves.*

- m) As soon as the engine starts, it reaches max RPM.

#### **4.5.13 Engine retraction on a ground**

After ground test runs don't retract the engine immediately. Allow the engine to cool down for a few minutes.

For retraction turn the propeller by hand into vertical position. Place the propeller brake on and switch extension/retraction switch to “retract position”. The engine will be retracted. To interrupt the retraction procedure simply switch extension/retraction switch to the neutral position.

Intentionally left blank

## Chapter 5 PERFORMANCE

5.1	Introduction.....	5-2
5.2	Data approved by EASA.....	5-2
5.2.1	Airspeed indicator system calibration .....	5-2
5.2.2	Stall speeds .....	5-3
5.3	Additional information.....	5-3
5.3.1	Demonstrated crosswind components .....	5-3
5.3.2	Glide performance .....	5-3
5.3.3	Flight polar.....	5-4
5.3.4	Powered flight performance.....	5-4
5.3.4.1	Rate of climb.....	5-4
5.3.4.2	Cruising flight .....	5-4
5.3.4.3	Maximum operational altitude .....	5-4

## 5.1 Introduction

This Chapter provides EASA approved data for airspeed calibration, stall speeds and take-off performance and non-approved further information. The data in the charts have been computed from actual flight tests with the sailplane in good condition and using average piloting techniques.

## 5.2 Data approved by EASA

### 5.2.1 Airspeed indicator system calibration

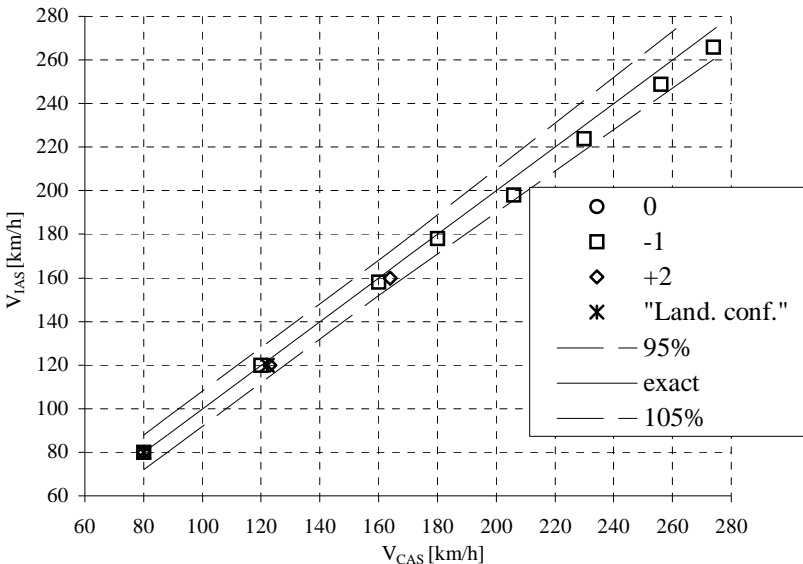

**Caution:** *The airspeed indicator is to be connected to the pitot source from the fuselage nose and static source from the aft fuselage part.*

Color coding of the plastic tubing is as follows:

- red - pitot;
- yellow - tail static;
- TE tube-green.

## 5.2.2 Stall speeds

Flap position	Stall speed in level flight, km/h (kts)	
	without water ballast	with maximum take off weight
L	85 (46)	93 (50)
+2	86 (46,5)	94 (51)
+1	87 (47)	96 (52)
0	88 (47,5)	97 (52)
-1	89 (48)	99 (53)

The loss of height for wings level stall recovery is approximately 30 m (100 ft) if recovery is immediate.

The loss of height for turning flights stall recovery is up to 50 m (164 ft) if recovery is immediate.

## 5.3 Additional information

### 5.3.1 Demonstrated crosswind components

The demonstrated crosswind velocity is 4,16 m/s (15 km/h) (8 kts.) according to the airworthiness requirements.

### 5.3.2 Glide performance

Data evaluated by comparison flights.

For optimum performance the aircraft should be flown with a C.G. position between medium and the rear of the allowable range. However, the aircraft will be more pitch sensitive at aft C.G. positions.

The wing fuselage joint and the tailplane locking *pin* should be taped *over* and the aircraft thoroughly cleaned to obtain maximum performance.

The polars apply to a clean aircraft, engine retracted. With dirty wings or flight in rain the performance drops accordingly.

### 5.3.3 Flight polar (will be correct)

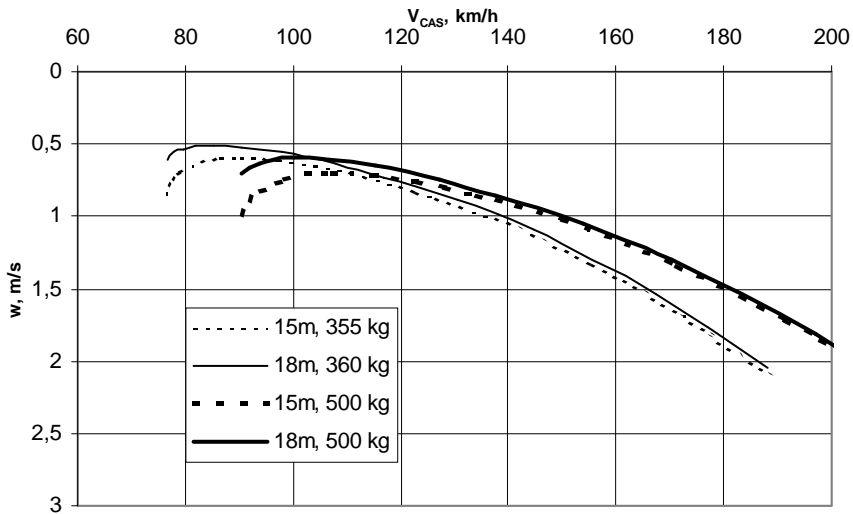

### 5.3.4 Powered flight performance

#### 5.3.4.1 Rate of climb

Measured rate of climb at MSL, standard atmosphere, flaps position “+2”, flying at a speed 95...100 km/h (51...54 kts) is:

- 2 m/s (395 ft./min) for maximum weight without water ballast;
- 1,2 m/s (235 ft./min) for maximum weight with water ballast.

#### 5.3.4.2 Cruising flight

The cruising speed is 95 km/h (51 kts) at max RPM.

#### 5.3.4.3 Maximum operational altitude

Maximum altitude that can be sustained at a standard atmosphere conditions (flaps at “+2”) is:

- 2800 m (9185 ft) for the maximum weight with water ballast;
- 3200 m (10500 ft) for the maximum weight without water ballast.



**Chapter 6**  
**WEIGHT AND BALANCE / EQUIPMENT LIST**

1

6.1	Introduction.....	6-2
6.2	Weighing procedures .....	6-2
6.3	Weighing record .....	6-2
6.4	Empty weight and C.G.....	6-3
6.5	Calculation of C.G. position .....	6-5
6.6	Weight of all non-lifting parts.....	6-7
6.7	Maximum weight .....	6-7
6.8	Useful loads .....	6-7
6.9	Water ballast loading table .....	6-8
6.10	Determining possible loading of the glider .....	6-8

## 6.1 Introduction

This Chapter contains the payload range within which the sailplane can be safely operated. Procedures for weighing the sailplane and the calculation method for establishing the permitted payload range are also provided. A comprehensive list of all equipment available for this sailplane is contained in the Maintenance Manual.

## 6.2 Weighing procedures

The Weight and Balance Report for the LAK-17BT must be calculated in accordance with the currently valid weighing data. The weighing must be established according following picture:

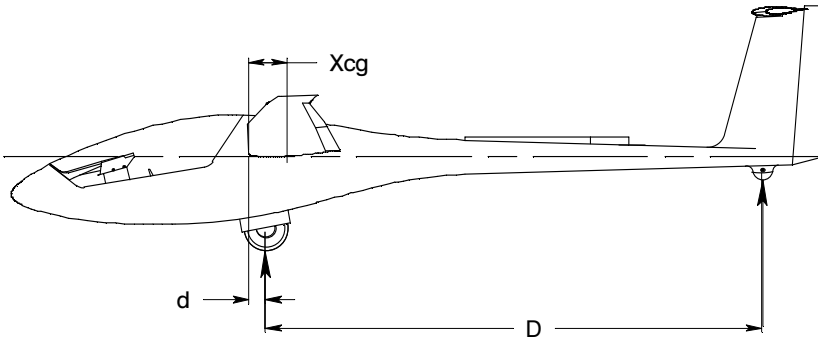

## 6.3 Weighing record

The result of each C.G. weighing is to be entered in the Weight and Balance Report in Chapter 6.4. The current minimum cockpit load must also be entered on the cockpit placard. When adding or changing instruments or equipment the new weighing report may be produced by a C.G. calculation using the following formula:

$$X_{cg} = \frac{G_2 * D}{G_1 + G_2} + d, \text{ mm}$$

## 6.4 Empty weight and C.G.

Approved in flight C.G. positions are:

No.	Parameter	Approved limit, mm
<b>In flight:</b>		
1	Foremost position of C.G. ( <b><u>critical for power-plant extracted</u></b> ).	206
2	Rearmost position of C.G. ( <b><u>critical for power-plant retracted</u></b> ).	328

**Warning:** *it is important to do weighing or calculation of c.g. for forward limit with **engine extracted** and for rear limit with **engine retracted** as engine position makes big influence for c.g. position.*

Weight and balance record

Date	Empty weight of the sailplane [kg]	C.G. location [mm]	Approved	
			Date	Signature
		Engine extracted:		
		Engine retracted:		
		Engine extracted:		
		Engine retracted:		
		Engine extracted:		
		Engine retracted:		
		Engine extracted:		
		Engine retracted:		
		Engine extracted:		
		Engine retracted:		

Date	Empty sailplane weight [kg]	C.G. location [mm]	Approved	
			Date	Signature
		Engine extracted: Engine retracted:		
		Engine extracted: Engine retracted:		
		Engine extracted: Engine retracted:		
		Engine extracted: Engine retracted:		
		Engine extracted: Engine retracted:		
		Engine extracted: Engine retracted:		
		Engine extracted: Engine retracted:		
		Engine extracted: Engine retracted:		
		Engine extracted: Engine retracted:		
		Engine extracted: Engine retracted:		
		Engine extracted: Engine retracted:		
		Engine extracted: Engine retracted:		
		Engine extracted: Engine retracted:		
		Engine extracted: Engine retracted:		

Empty weight center of gravity of the LAK-17BT with the power-plant installed is defined for the 15m wing configuration, fuel tank empty, water ballast tanks empty, glider ready to fly, excluding weight of pilot and parachute.

**Warning:** *fin battery has to be removed. Only the baggage compartment batteries can be installed.*

**Warning:** *due to flutter reasons it is not allowed to add additional masses to the fin battery or the fin battery compartment.*

**Note:** *if pilot weight is 100...110 kg (220,5...242 lbs), it is possible to remove one baggage compartment battery and replace it by installing battery in the fin. This moves c.g. of the glider back by 32...34 mm. Re-weighing or re-calculation of the c.g. position is mandatory in this case.*

Removable ballast used to supplement the weight of an occupant and parachute (when lower as minimum cockpit load) in order to keep C.G. position within limits is fastened in fuselage nose. The 1,75 kg (3,9 lbs) of removable ballast equals a pilot weight of 5 kg (11 lbs).

The permissible range of empty glider center of gravity is given below:

## 6.5 Calculation of C.G. position

Center of gravity position after loading glider (additional instruments, equipment, water ballast, pilot) is defined as:

$$X_{CG} = \frac{\sum_n G_n * X_n}{\sum_n G_n}, \text{ mm}$$

Where:  $G_n$  = the glider component mass, kg;

$X_n$  = distance between glider component mass C.G. and wing root leading edge, mm;

distance “-“ if mass C.G. is ahead of the wing root leading edge;

distance “+” if mass C.G. is behind of the wing root leading edge;

$n$  = number of glider components;

$\Sigma G_n$  = sum of all glider components masses;

$\Sigma G_n * X_n$  = sum of moments of all glider components masses;

The C.G. calculation table

No	Component	Weight $G_n$	Distance $X_n$	Moment $G_n * X_n$
----	-----------	-----------------	-------------------	-----------------------

		kg	mm	kg * mm
1.	Empty glider. Engine: -extracted * - retracted *			
2.	Pilot			
3.	Battery in fin	3,5	4192	
4.	Battery in baggage compartment	2,6	157	
5.	Water ballast in wings		168	
6.	Water ballast in fin		4003	
7.	Instrument N1 in instrument panel		-1010	
8.	Instrument N2 in instrument panel			
-				
n-1	Removable ballast in fuselage nose		-1785	
n	Baggage weight		150	
	$\Sigma G_n =$		$\Sigma G_n * X_n =$	

\* - these data for columns Weight  $G_n$  and Distance  $X_n$  should be taken from current "Weight and balance record" table (paragraph 6.4) as  $G_n =$  "Empty weight of the sailplane" and  $X_n =$  "C.G. location".

$$X_{CG} = \frac{\sum_n G_n * X_n}{\sum_n G_n}, \text{ mm}$$

**Note:** *The glider empty weight and empty weight center of gravity are defined by weighting data.*

**Warning:** *it is important to do weighing or calculation of c.g. for forward limit with **engine extracted** and for rear limit with **engine retracted** as engine position makes big influence for c.g. position.*

- Pilot: actual pilot weight with parachute:
  - distance X = -520 mm, when pilot seat is in the rearmost position;
  - distance X = -670 mm, when pilot seat is in the foremost position.
- Water ballast in a wings: actually filled water ballast weight.
- Water ballast in a fin: weight of actually filled water ballast in to the fin tank.
- Baggage weight: weight of baggage in a baggage compartment weight.

## 6.6 Weight of all non-lifting parts

Weight of non-lifting parts of the sailplane includes weight of pilot, fuselage, stabilizer with elevator, rudder, instruments and equipment.

Maximum weight of non-lifting parts of the LAK-17BT is 290,2 kg (639,8 lbs).

## 6.7 Maximum weight

The maximum approved take-off and landing weight is 550 kg (1212,5 lbs) for 15m wing and 600 kg (1322,8 lbs) for 18m wing..

## 6.8 Useful loads

The maximum useful load of the LAK-17BT is equal to the maximum approved take-off and landing weight minus the empty weight of the aircraft plus the weight of any added water ballast.

## 6.9 Water ballast loading table

The max permissible water ballast weight (kg) is given in the following table.

Mass of pilot with parachute (kg)	Sailplane empty weight (kg) + fin ballast weight (kg)						
	270	275	280	285	290	295	300
70	160	155	150	145	140	135	130
75	155	150	145	140	135	130	125
80	150	145	140	135	130	125	120
85	145	140	135	130	125	120	115
90	140	135	130	125	120	115	110
95	135	130	125	120	115	110	105
100	130	125	120	115	110	105	100
105	125	120	115	110	105	100	95
110	120	115	110	105	100	95	90

Maximum capacity of wing tanks.....188 liter (49,6 US gal).

Maximum capacity of fin tank.....8 liter (2,11 US gal).

## 6.10 Determining possible loading of the glider

The allowed fin water ballast depending on a pilot weight is given in a charts below in this chapter. Charts are the same for both 15m and 18m wing.

Fin water ballast is only usable to compensate the pilots moment.

**Warning:** *It is not allowed to use the fin water ballast to bring back a heavy pilot into the allowed C.G. range. In that case jettisoning the fin water ballast will cause a C.G. position out of the allowed range.*

The example how to determine possible loading of the glider:

Sailplane empty weight.....	273 kg;
Empty weight center of gravity.....	478 mm;
Pilot with parachute weight.....	80 kg;
Wing span.....	18 m.



According to the graph “Sailplane LAK-17BT empty center of gravity” - the empty weight C.G. is in permissible range.

According to the graph “Sailplane LAK-17BT (15m) empty center of gravity, pilot weight 80 kg” – the allowed fin water ballast weight is 0 - 5 kg.

If:

- fin water ballast weight is 4 kg;
- sailplane empty weight + fin ballast weight = 273 kg + 4 kg = 277 kg;
  - pilot with parachute weight=80 kg.

According to the “Water ballast loading table” - the max permissible wing water ballast weight is  $\approx 140$  kg.

Intentionally left blank

**Chapter 7**  
**SAILPLANE AND SYSTEMS DESCRIPTION**

7.1	Introduction.....	7-2
7.2	Airframe construction .....	7-2
7.3	Flight controls and trim.....	7-4
7.4	Airbrakes and wheel brake.....	7-4
7.5	Flaps.....	7-5
7.6	Landing gear .....	7-5
7.7	Tow release.....	7-5
7.8	Canopy operation.....	7-5
7.9	Water ballast system .....	7-6
7.10	Cockpit ventilation.....	7-6
7.11	Seat back adjustment.....	7-7
7.12	Baggage compartment.....	7-7
7.13	Safety harness .....	7-7
7.14	Pitot and static pressure system.....	7-7
7.15	Miscellaneous equipment.....	7-8
7.15.1	Oxygen system.....	7-8
7.15.2	Emergency locator transmitter .....	7-8
7.16	Radio transceiver .....	7-8
7.17	Power-plant controls .....	7-8
7.18	ILEC MCU (Motor Control Unit).....	7-9

## 7.1 Introduction

This Chapter provides a description of the sailplane, its systems and provided standard equipment with instructions for use.

## 7.2 Airframe construction

The LAK-17BT is a single seat high performance self-sustaining sailplane designed to meet FAI 15m and 18m Class requirements. The wings are constructed with glass and carbon fiber reinforced plastic over a plastic foam core with carbon rod spar caps. The ailerons are from carbon fiber reinforced plastic. The fuselage is made using glass fiber reinforced plastic with Kevlar and carbon for local stiffness. The stabilizer, elevator and rudder are glass fiber reinforced plastic over plastic foam core.

Cockpit layout description is given below and at the pictures page 7-3:

1. Seat back adjustment handle.
2. Trim control knob.
3. Flaps control handle.
4. Airbrakes control handle.
5. Tow release knob.
6. Canopy latching handle.
7. Rear view mirror.
8. Cockpit ventilation knob.
9. Canopy jettison handle.
10. Instrument panel.
11. Rudder pedals.
12. Landing gear control handle.
13. Water ballast control handle.
14. Rudder pedals control handle.
15. Propeller brake control lever.
16. Fuel valve control knob.
17. Tail water ballast control handle (optional).
18. Side pocket.
19. De-compressor control lever.
20. Wheel brake control lever.
21. Control stick.
22. Safety harness.



### 7.3 Flight controls and trim

The ailerons and elevator are operated from the central control column (control stick).

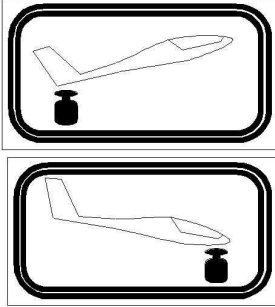

The trim adjustment control knob is located *in the left armrest* and controls the elevator trim select position. See Maintenance Manual Section 2. To set the trim, simply move the adjustment knob to the desired trim position.



The rudder pedals control the rudder by a cable system and are adjusted using the gray knob located in the right armrest. Pull the knob to loosen the rudder pedal lock, make the adjustment, and release the knob to lock the rudder pedals in the desired position.

### 7.4 Airbrakes and wheel brake

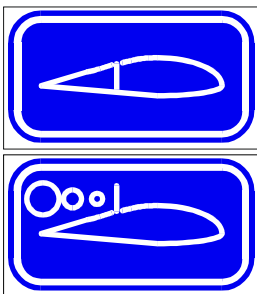

The airbrakes are operated by the blue control handle located on the left cockpit wall. Pull the handle back to extend the airbrakes and push forward to retract and lock.

The wheel brake is actuated via the handle on the control stick. See Maintenance Manual Section 2.

## 7.5 Flaps

The flaps are operated by the gray control handle located on the left cockpit wall. For more information see Maintenance Manual Section 2.

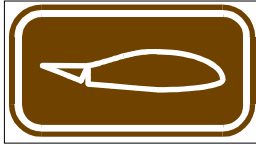
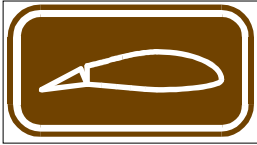

## 7.6 Landing gear

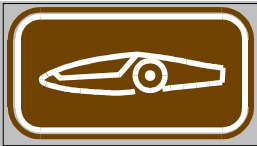
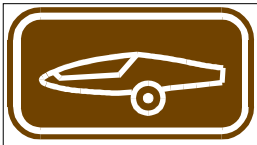

The landing gear is extended and retracted with the gray control handle located in the right hand armrest. Landing gear locked positions are located at either end of the control handle travel. Forward to extend, back to retract. The system is assisted by a nitrogen gas strut. See Maintenance Manual Section 2.

## 7.7 Tow release

The tow release is the yellow control knob located at the left side wall of the cockpit. Pull this control knob to open the tow release and release the knob to allow the tow coupling to snap closed and lock.

## 7.8 Canopy operation

To jettison the canopy pull the red canopy release handle firmly back and release it. A spring will push the front of the canopy up. This allows the airflow to lift it up and carry it away.

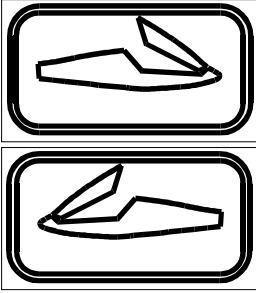

The canopy latching handles are black and are located on either side of the canopy frame. Pull the handles back to lock and push forward to un-lock. Never use the window opening to lift or lower the canopy. Cracks in the canopy will result. When sitting in the cockpit use the small tabs on the frame to raise and lower the canopy.

### 7.9 Water ballast system

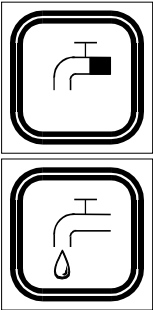

In a standard configuration the tank valves for the wing and tail open simultaneously with one knob. The water ballast valves control knob is located on the right side of the cockpit wall. To open the dump valves move the knob to the back and to close the dump valves move the knob forward.

(If the sailplane has an independent (optional) control system for the fin tank valve - the water ballast valve control knob of the fin tank is located on the right side of the cockpit wall. To open the dump valve move the knob to the back and to close the dump valve move the knob forward).

See Maintenance Manual Section 2.

### 7.10 Cockpit ventilation

The canopy de-mist vent control is located on the instrument panel. Pull to open, push to close.



### **7.11 Seat back adjustment**

Seat back adjustment is accomplished by using the squeeze ring located on the left cockpit side.

### **7.12 Baggage compartment**

Hard objects cannot be carried in the baggage compartment without a suitably designed lashing or anchorage. The baggage compartment load must not exceed 7 kg (15,4 lbs).

### **7.13 Safety harness**

A safety harness with four fixed attachment points is provided.

### **7.14 Pitot and static pressure system**

The fuselage-mounted tubes provide the pitot and static pressure.

**Warning:** *An air leak will adversely affect airspeed indication and other instruments. Make sure the probe is fully seated in the receptacle for proper operation.*

See Maintenance Manual Section 2.

## 7.15 Miscellaneous equipment

### 7.15.1 Oxygen system

The oxygen system (Aerox Oxygen, type E or M) must be operated in accordance with the instructions provided by the manufacturer (Aerox Oxygen, type E or M) of the system.

**Caution:** *Installation of the oxygen system (Aerox Oxygen, type E or M) must be accomplished by the aircraft manufacturer or by a certified aircraft mechanic, according to national rules and regulations. An authority aircraft inspector must approve the installation.*

### 7.15.2 Emergency locator transmitter

The system must be operated in accordance with the instructions provided by the manufacturer of the Emergency Locator Transmitter system. See the Maintenance Manual, Section 2, for recommended installation places.

**Caution:** *Installation of the Emergency Locator Transmitter must be accomplished by the aircraft manufacturer or by a certified aircraft mechanic, according to National rules and regulations. An authority aircraft inspector must approve the installation.*

## 7.16 Radio transceiver

The radio station of type Becker or Filser should be used.

## 7.17 Power-plant controls

The LAK-17AT has the following power-plant controls in a cockpit:

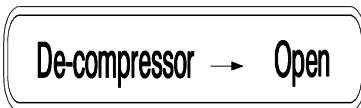

De-compressor valves control handle - is located forward of control stick. To the right to "open", release to close.

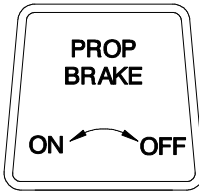

Propeller brake - handle is located on a right-side cockpit wall. Handle in the “on” and “off” positions is locked in a guiding plate.



Fuel Valve controls handle - located on a right-side cockpit wall.

## 7.18 ILEC MCU (Motor Control Unit)

### MCU Operation

The MCU was designed to improve safety of engine use. This important MCU function can only be obtained when MCU is always (continuous) switched on when operating the engine. Any other use is outside of manufacture agreed MCU operation mode.

If MCU is switched off during engine run, all safety in engine operation is lost.

To have a sure detection for use outside agreed operation, MCU stores error and operation information.

#### **Caution:**

*Keep MCU power supply always switched on during engine run!  
Do not switch to other battery during engine run (like MCU power supply off / power supply on)!  
Keep extract switch in top position during engine run!  
If MCU inadvertently was switched off during engine run, stop engine first (ignition off), switch on MCU again and after start engine again!  
Squeeze danger - be careful when retracting or extracting engine on ground! It is extremely dangerous to operate engine on ground (e.g. for tests)!*

**Disclaimer:**

ILEC is not responsible for accidents and damages caused by MCU during engine run outside the as agreed operation mode.

**Instrument indications**

The MCU for LAK17AT sailplane has on its front side, seven LED showing the most important states of the engine during all operation time. Additional a LCD display gives more detailed information about the same states and other values. On the front side are also switches for ignition on/off, engine ex-/retract and a button for display choice. On the back side are two different connectors placed for signal/power interfacing and ignition.

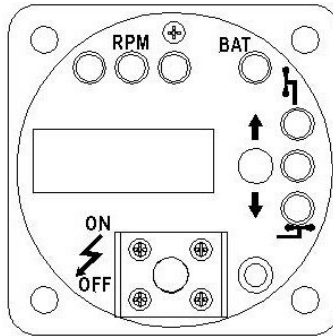
**Abbreviations**

CHT	<u>C</u> ylinder <u>H</u> ead <u>T</u> emperature
EEPROM	<u>E</u> lectrically <u>E</u> rasable <u>P</u> rogrammable <u>R</u> ead <u>O</u> nly <u>M</u> emory
LCD	<u>L</u> iquid <u>C</u> rystal <u>D</u> isplay
LED	<u>L</u> ight <u>E</u> mitting <u>D</u> iode
MCU	<u>M</u> otor <u>C</u> ontrol <u>U</u> nit
RPM	<u>R</u> otations <u>P</u> er <u>M</u> inute

**Power up sequence**

After powering up, MCU activates for two seconds all LED outputs, the buzzer output and the "88888888" display content. This procedure is for testing all indicators. The pilot should have a look during power up at MCU to recognize if all indicators work well.

**LCD Display Description**

The LCD display shows different information about engine, fuel tank, battery state and also advice during wrong handling. To change between different display pages simply press the white display button. Each short press on the button changes to the next display page. After last page, the first page comes again. When stopping on another page than the main page after a certain time the display switches automatically back to the main page. Also automatic switching to the most important display value is performed when engine parameters over or under run.

Pos.	Description	Run display example	Engine off/cold	Error
1	Rotations per minute (RPM) - main page	RPM 5500	RPM-----	RPM-----
2	Cylinder head temperature (CHT)	CHT230°C	CHT-----	CHT275°C (blinking)
3	Fuel tank level	FUEL 5L	FUEL 5L	FUEL ---
4	Battery voltage	BAT12,5V	BAT12,5V	BAT11,4V (blinking)
5	Engine hours	1,23h	1,23h	-
6	Fuel type correction		[100]	-
7	Fuel type calibration		Calibr.? (only retracted)	ERROR (after calibration)

The following handling errors displayed automatically:

Display	Required handling to go on
IGNI.OFF	Switch ignition off
IGNI.ON	Switch ignition on
PROPSTOP	Change state of propeller stop
EXTRACT	Extract engine

The following system errors displayed automatically:

Display	Reason	Possible Error reason
SWITCH R	Time overflow retract procedure	Limit switch retracted, wiring, spindle relays, spindle engine, fuse, battery voltage....
SWITCH E	Time overflow extract procedure	Limit switch extracted, wiring, spindle relays, spindle engine, fuse, battery voltage....
SWITCH O	Time overflow door open procedure	Limit switch door opened, wiring, door relays, door engine, fuse, battery voltage....
SWITCH C	Time overflow door close procedure	Limit switch door closed, wiring, door relays, door engine, fuse, battery voltage....

In retracted engine position the Display shows the following moving text:  
ILEC MCU LAK17BT xxxxx Hy.yy Sz.zz

**Explanation:**

xxxxx: Serial number  
Hy.yy: Hardware version  
Sz.zz: Software version

**Buzzer**

The buzzer gives additional acoustic information to the pilot during handling errors, dangerous engine states or malfunction. After buzzer starting, reason is displayed on the LCD display!

**Handling errors produce a pulsed buzzer tone**

High RPM, high CHT, low fuel level, low battery voltage and malfunction produce a continuous buzzer tone.

A continuous buzzer tone of low fuel level and low battery voltage can be switched off for a time of four minutes by pressing the display button, while a buzzer tone caused by High RPM and high CHT cannot be switched off. After four minutes the buzzer signal switches on again (when the alarm is still active). It is possible to switch it off (acknowledge) again by the display button.

All buzzer alarms are switched off, when engine is fully retracted in fuselage!

**Note:** *during negative acceleration, when engine is retracted, sometimes engine can go off the retracted position end switch, which will cause warning indication by MCU. Warning will go off as soon as negative acceleration will disappear.*

Reason	Buzzer	Display	LED	Remark
4500<RPM<5800	-	RPM	Green RPM on	
5800≤RPM<6500(<5min)	-	RPM	Yellow RPM on	
5800≤RPM<6500(≥5min)	continuous	RPM (blinking)	Yellow RPM blinking	
RPM>=6500	continuous	RPM (blinking)	Red RPM blinking	<b>MCU does not limit max. RPM!</b>
CHT≥275°C	continuous	CHT (blinking)	-	
Battery voltage≤11.5V	Continuous (reset able)	BAT (blinking)	Red BAT blinking	Acknowledge by white display button (4 min.)
Fuel ≤ 2L	Continuous (reset able)	FUEL (blinking)	-	Acknowledge by white display button (4 min.)
Time overflow extract procedure	Continuous (reset able)	SWITCH E	-	Acknowledge by display button or extract/retract switch in center position
Time overflow retract procedure	Continuous (reset able)	SWITCH R	-	Acknowledge by display button or extract/retract switch in center position
Time overflow open door procedure	Continuous (reset able)	SWITCH O	-	Acknowledge by display button or extract/retract switch in center position
Time overflow close door procedure	Continuous (reset able)	SWITCH C	-	Acknowledge by display button or extract/retract switch in center position
Push retract switch while ignition is on.	Pulsed	IGNI.OFF	RED handling blinking	
Increasing RPM while ignition is off.	Pulsed	IGNI.ON	RED handling blinking	
Ignition is on and propeller is blocked by propeller stop.	Pulsed	PROPSTOP	RED handling blinking	
Push retract switch while ignition is off and propeller is unblocked by propeller stop.	Pulsed	PROPSTOP	RED handling blinking	
Push retract switch while propeller is not in retract position	Pulsed	PROP.POS	RED handling blinking	
Switch ignition on while engine is not fully extracted	Pulsed	EXTRACT	RED handling blinking	

### Engine extract / retract

To extract the engine the switch on the right side of the LCD display has to be switched to top. First the door opens till the limit switch for opened door activates. After this the engine extracts till the limit switch for engine is activated and then the door closes back.

To retract the engine the same switch has to be switched down. First the door opens before engine retracts. Door opening is finished when limit switch of the door is activated. Engine retract stops when the limit switch in full retract position is activated. After this the door closes till the limit switch of the closed door activates. Is the engine partly extracted, always the door opens before the engine extracts/retracts.

**Caution:** *It is strongly recommended to let the re-/extract switch during engine run in top position after extract procedure!*

When in movement all tract operation stops when switching the ex-/retract switch to centered position.

### **Ignition switch**

The manual ignition switch is placed under the LCD display. This ignition switch works independent from MCU electronic.

When switched to top – ignition is on.

In lower position - ignition is switched off.

### **LED**

Above the LCD display three LED sign three RPM ranges.

Left green LED signs RPM of 4500 till 5800.

Middle yellow LED signs RPM of 5800 till 6500.

Right red LED (blinking) signs RPM above 6500.

On the right side of the RPM LED is the low battery LED which is blinking at battery voltage lower than 11,5V.

Extracted position green LED.

Handling error red LED.

Retracted position green LED.

### **Engine hours**

Engine hours counted at RPM higher than 2000 and stored in non-volatile EEPROM.



## Calibration of fuel type

Two stroke engines use a mix of oil and gasoline. The share of oil but also gasoline of different company influences the fuel level sensor. With an easy procedure in MCU this trouble could be solved.

When you are sure that the fuel tank is totally filled, choose the calibration page (press display button 6 times from RPM display) on MCU display. Press the display button for about five seconds. This procedure generates a new fuel type correction factor, which is displayed after five seconds.

Is the new correction factor outside 71% and 129%, an error message is displayed. This error must be acknowledged by pressing the display button. In this case old correction factor is restored.

**Warning:**      *It is absolutely dangerous to do a calibration with partly filled fuel tank, because MCU will measure and display wrong fuel quantity.*

The calibration procedure is only possible when engine is fully retracted!  
Fuel type calibration should be made when using different gasoline and oil.  
In best case do it after every filling fuel tank!

## Operating environment

The MCU is designed for operating at environment of the -20°C (-4°F) to +60°C (+140°F) temperature range. At lower or higher temperatures MCU can function improperly.

Intentionally left blank

**Chapter 8**  
**SAILPLANE HANDLING, CARE AND MAINTENANCE**

8.1	Introduction.....	8-2
8.2	Inspection periods and maintenance .....	8-2
8.3	Alterations and repairs .....	8-2
8.4	Tie down .....	8-2
8.5	Sailplane trailer .....	8-3
8.6	Ground handling .....	8-3
8.7	Cleaning .....	8-3

## 8.1 Introduction

This chapter contains the manufacturer's recommended procedures for proper handling and servicing of the sailplane. It also identifies certain inspection and maintenance activities, which are needed to retain performance and dependability.

## 8.2 Inspection periods and maintenance

The Instructions for Continued Airworthiness as provided in the LAK-17BT Maintenance Manual must be followed. Before each rigging, all connecting pins and bushings should be cleaned and greased. Also, at least once a year the control surface displacements and adjustments must be inspected to insure conformity with factory data. See the LAK-17BT Maintenance Manual for additional information.

## 8.3 Alterations and repairs

It is essential that the responsible airworthiness authority be contacted prior to any major alterations on this sailplane to ensure that the airworthiness is not impaired. Major alterations without approval from the manufacturer are prohibited. Furthermore, the manufacturer will not be held liable for unapproved alterations or for damages resulting from changes in the characteristics of the aircraft due to these alterations. External loads from camera installations are to be regarded as major alterations. Repair instructions are located in the Maintenance Manual Section 8. No repair should be performed to this aircraft without referring to Maintenance Manual. When in doubt as to the suitability of a repair contact the manufacture.

**Caution:**      *No additional color marking on the white upper surface is allowed.*

## 8.4 Tie down

The recommended tie down points are the tow release, wing tips and fuselage tail just ahead of the vertical fin. The cockpit always must be closed and covered when tied down.

Note: The external surfaces of the LAK-17BT are finished in a durable epoxy paint, however long exposure to sun and humidity will lead to premature aging of any surface finish.

## **8.5 Sailplane trailer**

A sailplane of this quality and value should be transported and stored in a high quality enclosed trailer constructed of metal or fiber glass reinforced plastics. Proper ventilation and UV blocking characteristics should be provided. The wings should be supported as close as possible to the inner most root rib and again at a point one third from the wing tip. The horizontal stabilizer may be stored vertically or horizontally. The fuselage should be supported in a fuselage dolly positioned just forward of the main landing wheel opening. Due to the angle of the fuselage in the trailer a forward stop must be provided for the fuselage dolly. Otherwise it will roll forward and leave the fuselage with no support. Forward and aft motion of the fuselage should be restricted with a felt lined nose cone support and a tail wheel well with a fuselage strap located just forward of the vertical fin.

## **8.6 Ground handling**

Ground towing should be accomplished using the tow release and standard double aero tow ring. Ground towing should also be accomplished with a tail dolly tow bar and wing tip wheel.

## **8.7 Cleaning**

The exterior painted surfaces should be cleaned with clear water using a sponge or soft cotton towel and chamois. These surfaces should also be protected with a silicone free hard wax reapplied at least once a year by hand or with a rotating cloth disc. Tape adhesives are best removed using pure petroleum spirits or wax containing a light polishing agent. Do not clean the exterior surfaces with alcohol, acetone or lacquer thinner.

Clean the Plexiglas canopy only as necessary using a soft cotton towel and clear water mixed with a small amount of mild detergent. Protect the canopy with anti-static cleaning agents which are made specifically for Plexiglas.

All non-painted metal surfaces must be regularly wiped clean and protected with a light coating of grease.

Intentionally left blank

**Chapter 9**  
**SUPPLEMENTS**

There are no supplements